

8-25-2017

A NOVEL APPROACH TO NEAR-REAL TIME MONITORING OF VENTILATION RATE AND INDOOR AIR QUALITY IN RESIDENTIAL HOUSES

Achalu Kuma Tirfe
Syracuse University

Follow this and additional works at: <https://surface.syr.edu/etd>

 Part of the [Engineering Commons](#)

Recommended Citation

Tirfe, Achalu Kuma, "A NOVEL APPROACH TO NEAR-REAL TIME MONITORING OF VENTILATION RATE AND INDOOR AIR QUALITY IN RESIDENTIAL HOUSES" (2017). *Dissertations - ALL*. 768.
<https://surface.syr.edu/etd/768>

This Dissertation is brought to you for free and open access by the SURFACE at SURFACE. It has been accepted for inclusion in Dissertations - ALL by an authorized administrator of SURFACE. For more information, please contact surface@syr.edu.

ABSTRACT

Physics-based infiltration models, like Lawrence Berkeley Laboratory (LBL) and Alberta Infiltration Model (AIM-2), have been used to predict infiltration rate in near real time. These models are constructed from the driving forces of wind and temperature difference across the building enclosure system, both of which cause pressure differences across the enclosure system for infiltration. The models incorporate other major factors like building leakage characteristics, distributions of openings, microenvironment conditions around the building enclosure as affected by building shields, topography and building shape. The accuracy of the models depends on getting these factors right. However, these factors are specific for individual buildings and measuring these factors in occupied buildings is difficult. In theory, these can be determined by using a generalized table and blower door test but it requires heavy equipment and skilled work force, which is difficult to implement in occupied houses.

In this dissertation, a methodology is developed to determine the air change rate (ACH) and indoor air quality (IAQ) in near-real time by combining a physics-based infiltration model with a tracer gas decay test method. The methodology is applicable to naturally ventilated houses. Existing infiltration models are modified explicitly to include the impact of the wind direction. The input data for the model also include indoor air temperature and weather data. Tracer gas method is used to determine the infiltration model parameters using a multi variable nonlinear regression analysis. Once these parameters are obtained, it is able to predict the ACH with 10% and 16% error for AIM-

2 and LBL models, respectively. This method does not require the blower door test. Furthermore, a low cost device, a combination of CO_2 sensor, solenoid valve and temperature sensor, has been developed to apply the methodology to measure ACH and IAQ in near-real time without the need for skilled personnel.

**A NOVEL APPROACH TO NEAR-REAL TIME MONITORING OF
VENTILATION RATE AND INDOOR AIR QUALITY IN RESIDENTIAL
HOUSES**

by
Achal Kuma Tirfe

B.Sc., Bahir Dar University, 2002
M.Sc., Royal Institution of Technology (KTH), 2009

Dissertation
Submitted in partial fulfillment of the requirements for the degree of
Doctor of Philosophy in Mechanical and Aerospace Engineering

Syracuse University
August 2017

Copyright © Achalu Tirfe 2017
All Rights Reserved

AKNOWLEDGEMENTS

I sincerely thank my advisor Professor Jianshun Zhang for the continuous encouragement, support, and guidance. I am also grateful for members of my committee and the Department of Mechanical and Aerospace Engineering staff and faculty.

I would like to thank my wife, my parents, my brothers and sister for their endless love and support.

Table of Contents

ABSTRACT
ACKNOWLEDGEMENTS.....	IV
LIST OF TABLES	VII
LIST OF FIGURES	VIII
SYMBOLS.....	X
1 INTRODUCTION	1
1.1 PROBLEM STATEMENT	5
1.2 RESEARCH OBJECTIVE	6
1.3 RESEARCH SCOPE	6
1.4 DISSERTATION OUTLINE	7
2 AIR INFILTRATION	8
2.1 AIR INFILTRATION MECHANISMS.....	8
2.1.1 <i>Driving force</i>	10
2.2 INFILTRATION MODELING.....	12
2.2.1 <i>Empirical models</i>	12
2.2.2 <i>Network Air infiltration model</i>	15
2.2.3 <i>Comparison of LBL, AIM-2 and BRE model</i>	26
2.2.4 <i>Drawbacks of existing infiltration models</i>	27
2.3 AIR CHANGE RATE AND BUILDING LEAKAGE CHARACTERIZATION MEASUREMENT.....	28
2.3.1 <i>Air pressurization and depressurization</i>	28
2.3.2 <i>Dynamic (AC) pressurization</i>	29
2.3.3 <i>Transient pressurization method</i>	30
2.3.4 <i>Tracer gas method</i>	30
2.3.5 <i>Acoustic Method</i>	34
2.4 EXISTING NEAR-REAL TIME ACH MEASUREMENTS DRAWBACKS.....	35
3 COMBINED IAQ MONITORING AND MODELING METHOD TO DETERMINE ACH NEAR REAL-TIME.....	36
3.1 INTRODUCTION	36
3.2 ASSUMPTION AND LIMITATION	37
3.2.1 <i>Single zone model</i>	37

3.2.2	<i>Well mixed condition</i>	37
3.2.3	<i>Measuring fluctuating ventilation using tracer gas decay method</i>	37
3.2.4	<i>CO2 as a tracer gas</i>	37
3.3	MODIFIED INFILTRATION MODELS	39
3.4	TRACER GAS TECHNIQUE TO MEASURE ACH	43
3.5	DETERMINING NEAR REAL TIME ACH BY COMBINED INFILTRATION MODEL AND TRACER GAS METHOD	46
4	EXPERIMENTAL FACILITY AND INSTRUMENTATION	50
4.1	TEST HOUSE AND LOCATION	50
4.2	INSTRUMENTATION	53
5	RESULTS AND DISCUSSION	55
5.1	INTRODUCTION	55
5.2	SINGLE ZONE MODEL AND WELL MIXED CONDITION	55
5.3	DECAY METHOD TO MEASURE VARYING VENTILATION	58
5.4	THE EFFECT OF TRACER GAS IN THE BACKGROUND	60
5.5	NON-LINEAR MULTI-VARIABLE REGRESSION TECHNIQUE TO DETERMINE AIR LEAKAGE CHARACTERISTICS, WIND FACTOR AND STACK FACTOR	62
5.6	COMPARE THE MODELS WITH OTHER STUDIES	76
5.7	THE IMPACT OF REGRESSION DATA SIZE AND DATA QUALITY	77
6	APPLICATION	82
6.1	APPLICATION	82
7	SUMMARY AND CONCLUSIONS	91
8	FUTURE WORK	93
9	APPENDIX	94
	APPENDIX A: PRESSURIZATION TEST PROCEDURE	94
	APPENDIX B: TRACER GAS DECAY TEST PROCEDURE	95
	APPENDIX C: TRACER GAS CONSTANT CONCENTRATION TEST PROCEDURE	96
10	REFERENCES	97
11	VITA	100

LIST OF TABLES

Table 1: US house air leakage at 50 Pa differential pressure (Sherman and Matson, 2002).....	2
Table 2 : Terrain factor (Awbi, 2003).....	11
Table 3: Stack coefficient.....	14
Table 4: Wind coefficient: wind shielding factor.....	14
Table 5: Values of stack and wind factors for BRE model (Awbi, 2003).....	17
Table 6: Terrain parameter (Sherman and Grimsrud, 1980).....	20
Table 7: Generalized Shielding Coefficient (Sherman and Grimsrud, 1980).....	20
Table 8: Wind Shelter Coefficient (Walker and Wilson, 1990).....	25
Table 9: Effect of tracer gas choice.....	32
Table 10: LBL and AIM-2 model summary.....	39
Table 11: The percentage error of tracer gases between the first and second floor...57	
Table 12: Model parameters obtained from regression test.....	64
Table 13: Average percentage error for LBL-Regression and AIM-2-Regression model.....	69
Table 14 : Comparison of AIM-2 regression with AIM 2 model done in other studies.....	76
Table 15 : Data size used in the regression.....	77
Table 16 : Data size used in the regression for the filtered data.....	80
Table 17: Model parameters obtained from regression test.....	89

LIST OF FIGURES

Figure 1: Factors that affect infiltration.....	3
Figure 2: Wind speed.....	40
Figure 3: Wind direction	41
Figure 4: NOAA and BEST wind speed ratio vs wind direction	41
Figure 5: Methodology to determine ACH near real time using tracer gas and weather data in the infiltration model.....	47
Figure 6: BEST laboratory	50
Figure 7: Best Lab surrounding (google map).....	51
Figure 8: Best lab Topography (http://nyfalls.com/maps/ny-maps-topo-24000/) ..	52
Figure 9: BEST lab equipment and arrangement	53
Figure 10: SF6 concentrations on first and second floors	56
Figure 11: CO2 concentration on first and second floors.....	56
Figure 12: Constant concentration verses constant injection.....	59
Figure 13: Indoor and Outdoor CO2 Concentration level	60
Figure 14: Air change obtained from constant concentration and decay method	61
Figure 15: Wind speed and wind direction data	63
Figure 16: Outdoor air temperature data.....	63
Figure 17: Air change obtained from constant concentration and decay method	65
Figure 18: ACH from measurement, AIM-2-Regression, and LBL-Regression	66
Figure 19: AIM-2-Regression result	67
Figure 20: LBL-Regression result.....	68
Figure 21: The error distribution of AIM-2 Regression and LBL-Regression.....	69
Figure 22: ACH due to wind effect.....	70

Figure 23: ACH due to stack effect	71
Figure 24: Comparison between measured and predicted ACH	73
Figure 25: AIM-2 model error distribution	74
Figure 26: ACH measured and ACH predicted using AIM-2 model.....	75
Figure 27: Impact of the data size in AIM-2-Regression model.....	78
Figure 28: Data distribution based on wind direction	79
Figure 29: Wind speed data for wind direction between 270 and 300 degree	79
Figure 30: Impact of the data size quality on AIM-2-Regression model	81
Figure 31: IAQ monitoring and measuring device	83
Figure 32: Device schematic diagram	83
Figure 33: CO2 concentration measurement.....	86
Figure 34: Wind direction	86
Figure 35: Data distribution in a wind direction.....	87
Figure 36: Wind speed.....	87
Figure 37: Indoor and outdoor temperature	88
Figure 38: Measured and predicted ACH.....	90

SYMBOLS

A= leakage area, ft^2 or m^2

A_e = Total effective leakage area, ft^2 or m^2

A_c =ceiling leakage area, ft^2 or m^2

A_f =floor leakage area, ft^2 or m^2

ACH = Air change rate, h^{-1}

B = interaction coefficient

b = width, ft or m

C = flow coefficient or building leakage characteristics, $\frac{cfm}{(in.of\ water)^2}$ or $\frac{m^3}{h(Pa)^n}$

C_c = ceiling building leakage characteristics, $\frac{cfm}{(in.of\ water)^2}$ or $\frac{m^3}{h(Pa)^n}$

C_f = floor building leakage characteristics, $\frac{cfm}{(in.of\ water)^2}$ or $\frac{m^3}{h(Pa)^n}$

C_w = wall building leakage characteristics, $\frac{cfm}{(in.of\ water)^2}$ or $\frac{m^3}{h(Pa)^n}$

C_{flue} =flue building leakage characteristics, $\frac{cfm}{(in.of\ water)^2}$ or $\frac{m^3}{h(Pa)^n}$

C_d = discharge coefficient

C_p = wind pressure coefficient

C_s = the wind shelter effect

C_t = Tracer gas concentration, ppm

g =gravitational acceleration, $\frac{ft}{s^2}$ or $\frac{m}{s^2}$

G_t = tracer gas generation rate, lb/min

h = height, ft or m

l = length, ft or m

m = mass, lbm or kg

\dot{m} = mass flow rate, $\frac{lbm}{min}$ or $\frac{kg}{min}$

n = flow exponent

N =Air change rate, h^{-1}

P =pressure, *in of water* or Pa

P_{ref} =Pressure reference 4 Pa

Q =flow rate, $\frac{ft^3}{h}$ or $\frac{m^3}{h}$

Q_w = wind induced infiltration, $\frac{ft^3}{h}$ or $\frac{m^3}{h}$

Q_s = stack induced infiltration, $\frac{ft^3}{h}$ or $\frac{m^3}{h}$

T = temperature, F or R

t = time, h^{-1}

V=volume, ft^3 or m^3

Z = the neutral pressure line fraction.

Greeks

v=wind velocity, mph

ρ =air density, $\frac{lb_m}{ft^3}$

f_s = stack coefficient

f_w = wind coefficient

Subscripts

w =wind

i = indoor

o=outdoor

NPL=neutral pressure height

lvg = leaving

ent= entering

t= tracer gas

1 INTRODUCTION

The housing sector uses around 40% of the total energy consumption in the U.S. (Skon et al., 2011; Younes et al., 2012). The rising cost of energy and instability of the energy market and the global climate change suggest that the world needs to rethink its energy usage. Different efforts and tight measures have been taken for sustainable development around the world since the 1970's oil crisis. One important area of improvement is building heating and cooling energy efficiency. Buildings lose heat by conduction, ventilation and infiltration. Infiltration accounts for up to 50% of the heating load for residential buildings (Younes et al., 2012). New standards are in place to make airtight buildings in order to reduce the house heating and cooling load. Old buildings, however, require retrofitting to improve their energy efficiency.

Engineers used different methods to predict the infiltration rate, which is also defined as Air Change Rate in terms of air changes per hour (ACH) –i.e., the total volumetric airflow rate ($\frac{m^3}{h}$ or $\frac{ft^3}{h}$) due to infiltration divided by the volume of the house (in m^3 or ft^3). A study from the Lawrence Berkeley National laboratory database on air leakage indicated that the normalized average leakage air change rate of old houses was 1.18 ACH with a standard deviation of 0.81 ACH at 50 Pa. In newly constructed houses, the leakage rate drops to 0.55 ACH for convectonal houses and even less for energy efficient houses as shown in table 1 (Sherman and Matson, 2002). Blower door test was used to measure the ACH. The test method is discussed in chapter two.

Table 1: US house air leakage at 50 Pa differential pressure (Sherman and Matson, 2002)

Program	No. of house	Normalized leakage	Standard Deviation	Method used
Conventional: Not built as a part of energy-efficient program	1200	0.55	0.55	Blower door
Energy efficient: Improved construction (non- Alaska home)	3100	0.31	0.13	Blower door
AKWarm: Program in Alaska	4400	0.23	0.1	Blower door

For most residential houses in the U.S, infiltration is the main source of ventilation. Airtight buildings raise concern in indoor air quality (IAQ) unless mechanical ventilation is used (Skon et al., 2011). According to the U.S. Environmental Protection Agency (EPA), people spend 90% of their time, on average, indoors and indoor air pollutant concentrations are 2 to 5 times higher than the outdoors. It is important to have adequate amount of infiltration or air change rate .

Infiltration airflow is driven by the pressure difference across the building envelope. For a naturally ventilated house with a certain leakage opening, this driving force is caused by the temperature difference between the inside and the outside climate as well as by the wind. They are unsteady and difficult to predict. Air tightness also plays an important role. Beside the air tightness, occupants' activities such as entering and

leaving the house, opening windows, turning on the kitchen or bathroom exhaust fan, also affect infiltration flow.

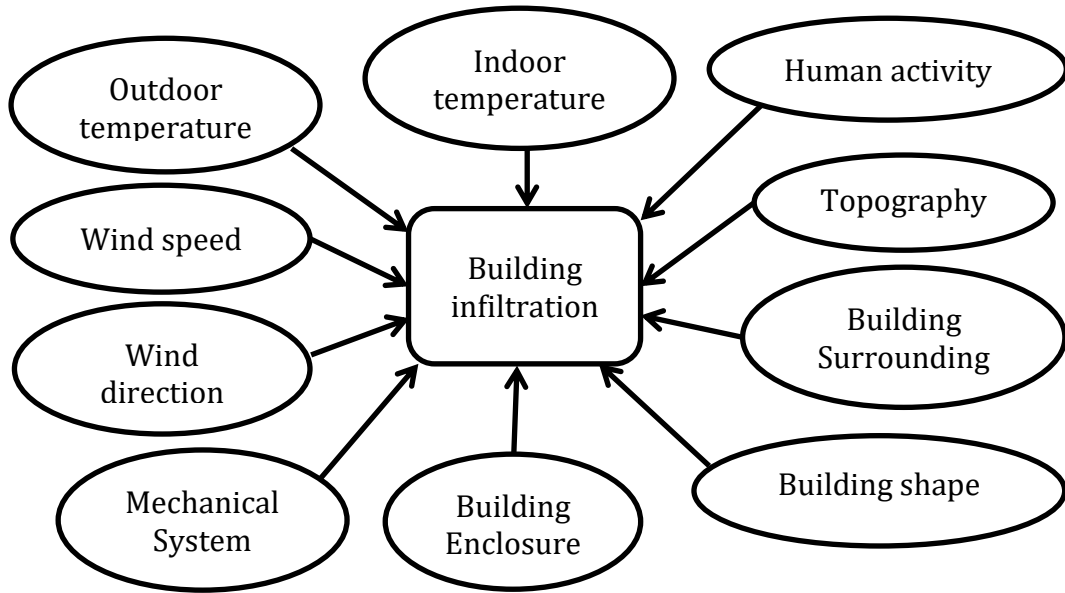

Figure 1: Factors that affect infiltration

Figure 1 shows factors that affect the infiltration mechanism in a naturally ventilated house. It depends on the indoor and outdoor temperature difference, wind speed, wind direction, building enclosure system, human behavior, building surroundings, building shape, building orientation, and topography.

The main question is how do we measure the ACH for occupied and naturally ventilated houses? Monitoring the indoor air quality of the house is important to create a healthy and comfortable environment. Temperature, relative humidity and CO₂ level are the most common parameters monitored for IAQ. Nevertheless, they are not sufficient to predict the ACH near-real time.

The two standard methods to measure ACH are the building pressurization method and tracer gas method. Building pressurization method is used to compare infiltration between buildings and to measure building leakage characteristics. However, it is not applicable to near real time infiltration measurement. Tracer gas method is the most accurate infiltration measurement near-real time. The choices of the tracer gas are limited. Most tracer gases are toxic, flammable or have impact on global warming. The presence of the occupant in the test site could affect the measurement for tracer gas like carbon dioxide. Therefore, tracer gas methods are also not applicable at occupant presence. Both tracer gas method and building pressurization method are expensive and inconvenient for continuous monitoring ACH in occupied residential houses.

Infiltration models are an alternative way to determine the infiltration rate in the building. The most common infiltration models are Reduction Pressurization Test, Regression Technique, ASHRAE Model, Building Research Establishment (BRE) model, Lawrence Berkley Laboratory (LBL) model, and Alberta Infiltration model (AIM-2). All the infiltration models require blower door test to determine building leakage characteristics, which is expensive and requires skilled labor. Physics based models, LBL and AIM-2, give a better prediction than the other imperial model. These models are constructed from infiltration driving forces: wind and stack effect induced pressure differences across the building enclosure. They also include all of the important parameters like neutral pressure level, wind shield effect and building leakage characteristics. The accuracy of these models heavily depends on quantifying these factors. However, these factors are specific to individual buildings. Building pressurization test, also known as blower door test, is essential to determine building

leakage characteristics, which requires expensive equipment and skilled labor. To overcome these challenges, this dissertation addresses the following two research questions:

1. Is it possible to measure ACH for occupied residential house by combining the infiltration model and tracer gas method with comparatively lower cost and less equipment for skilled work force?
2. Is it possible to determine the leakage characterizes without the blower door test?

1.1 Problem statement

Continuous monitoring of the infiltration rate for naturally ventilated residential buildings has an impact on understanding energy lost mechanisms as well as indoor air quality. This information will help homeowners to understand the indoor air quality of the house as well as the building leakage characteristics to take action in a timely manner and create an energy efficient and healthy building. To do this, measuring ACH for naturally ventilated houses plays a vital role.

The only currently available direct method to measure ACH continuously is constant concentration tracer gas method. The equipment is sophisticated and expensive. Most tracer gases used for this technique are toxic and flammable, which cannot be used at the presence of occupants. Moreover, they can contribute to global warming. Therefore, it is difficult to continuously monitor ACH in naturally ventilated residential buildings.

The indirect way to predict the infiltration is to use the infiltration model based on the indoor and outdoor climate conditions. The current available ACH models have error up to 100 times (Lordache and Catalina, 2012). They require building blower door test to determine building air leakage characteristics. This test requires skilled labor and expensive equipment.

In this dissertation, a methodology is developed to measure ACH for naturally ventilated buildings near real time by combining the infiltration model and CO₂ measurements with less expensive equipment.

1.2 Research objective

The objectives of this research are to:

- develop a method to monitor infiltration rate for naturally ventilated houses in near-real time.
- develop a method to diagnosis a building envelope system by monitoring the IAQ, weather, ACH and energy consumption.

1.3 Research Scope

This work is limited to the following conditions:

- Single family houses with light frame structure
- Infiltration is the main source of ventilation which is affected by climates, building enclosure and building micro environment

1.4 Dissertation Outline

This dissertation is organized in six chapters. The chapters are summarized below:

Chapter 2 Literature review: Available infiltration measurement and available infiltration models for naturally ventilated houses are investigated. The driving force, leakage mechanisms, and factors that affect infiltration are reviewed. The drawbacks of the existing near-real time infiltration measurement and models are also discussed.

Chapter 3 Combines IAQ monitoring and modeling method to determine ACH near real time: A methodology is developed to measure ACH by combining IAQ monitoring and an infiltration models. The wind induced infiltration equation is modified to include the effect of wind direction.

Chapter 4 Experimental facility and instrumentation: A detail description of the test facility and the equipment used to validate the proposed methodology are presented.

Chapter 5 Results and discussion: Experiments are done to validate assumptions and limitations taken to develop the methodology. The results and discussions are presented in this section

Chapter 6 Application: A low cost monitoring device is introduced to apply the developed methodology in a single-family house. This chapter describes the device and its application.

Chapter 7 Summary and Conclusions: Major findings of the research are summarized.

Chapter 8 Future works: Future works are discussed to make the proposed technique applicable, affordable, and accessible.

2 AIR INFILTRATION

Infiltration is the main source of ventilation for most residential buildings in the U.S. Therefore, it is important to measure or predict the impact of infiltration to understand the heating and cooling energy consumption and indoor air quality. Different measuring and infiltration prediction models are used to determine infiltration rate in naturally ventilated houses. The infiltration mechanism, infiltration model, and infiltration measurement techniques are discussed in this chapter.

2.1 Air Infiltration mechanisms

Infiltration is caused by the pressure difference across the building envelop, which is not 100% airtight. The air tightness of the building enclosure system is dependent of the building material and workmanship of the building construction. Wind and temperature difference between the indoor and outdoor climate creates the pressure difference that causes the air to leak through the opening and cracks of the building envelop. Depending upon the size and distribution of leakage paths, air leakages are categorized as:

1. Concentrated leakage: this is leakage through a large opening (door and/or window) and cracks with short path. It only has heat loss, not condensation. The flow is turbulent and it is defined by the following orifice equation:

$$Q = C_d A \sqrt{\frac{2\Delta P}{\rho_0}} \quad \text{eqn(1)}$$

where A is leakage opening area, ΔP is pressure difference across the opening, C_d is discharge coefficient and ρ is air density

2. Diffuse leakage: this is leakage through small cracks in the wall and others in which air travels long distance. It causes heat loss and condensation. Flow is laminar and expressed in a Couette flow equation:

$$Q = \frac{bh^3}{12\mu l} \Delta P \quad \text{eqn(2)}$$

where, b is the length, h the height of the crack's cross section, l is the length of leakage path in flow direction, and μ is the viscosity of air.

The above two equations can be presented by a single power law equation:

$$Q = C(\Delta P)^n \quad \text{eqn(3)}$$

where, ΔP is pressure difference across the building enclosure, C is the flow coefficient, n is the flow exponent which is between 0.5 and 1 (corresponding to fully developed turbulent flow and laminar flow, respectively). In practice this value is between 0.6 and 0.7. (Awbi, 2003).

The value of C and n are defined by a multi-point pressurization/depressurization test also known as blower door test. The flow coefficient (C) depends on the building material and workmanship. The flow exponent (n), however, reflects the type of leakage (i.e. concentrated or distributed).

2.1.1 Driving force

Leakage through building enclosure is driven by pressure difference. This pressure difference is mainly caused by wind and/or thermal buoyancy (Stack effect). Gusting wind controls the infiltration for low-rise buildings. For high-rise buildings, stack effect can cause significant air movement. These driving forces act independently (Younes et al., 2012).

2.1.1.1 Wind effect

Wind pressure depends on wind velocity, wind direction, local terrain, topography and building shape (Younes et al., 2012).

Pressure caused by wind is derived from the Bernoulli equation as:

$$\Delta P_w = 0.5C_p\rho v^2 \quad \text{eqn(4)}$$

where, C_p is the wind pressure coefficient, ρ is air density, and v is wind velocity.

The value of C_p incorporates factors that affect the wind pressure, such as building geometry, wind velocity, and building exposure (surrounding, topography, and roughness of the terrain in the wind direction) (Younes et al., 2012).

According to Awbi (2003), wind speed from weather station needs evaluation since the speed is affected by different factors. The mean wind speed is determined as follows:

$$\frac{v}{v_r} = bH^a \quad \text{eqn(5)}$$

where, v_r is the mean wind speed from the weather station, H is the height above ground, and a and b are terrain parameters given in Table 2.

Table 2 : Terrain factor (Awbi, 2003)

Terrain	<i>b</i>	<i>a</i>
Open flat country	0.68	0.17
Country with scatter wind break	0.52	0.20
Urban	0.35	0.25
City	0.21	0.33

2.1.1.2 Stack effect

Stack effect is caused by the temperature difference across the building envelope.

Pressure difference induced by stack effect is given as: (Lawrence Berkeley National Laboratory, 2006; Sherman and Matson, 2002)

$$\Delta P_s = -\rho g(h - H_{NPL}) \left(1 - \frac{T_0}{T_i}\right) \quad \text{eqn(6)}$$

where, h is height, H_{NPL} is neutral pressure height, and T_i and T_0 are the indoor and outdoor temperature, respectively.

Determining the neutral pressure height is difficult. Shaw [9] found that the ratio of neutral pressure plane height with the building height is around 0.7 from two school buildings. This ratio is recommended to be between 0.2 and 0.7 (Lawrence Berkeley National Laboratory, 2006).

2.2 Infiltration modeling

Estimating air infiltration is important in designing the HVAC system of a house. Currently different models are available to estimate the ACH. In general, these models can be categorized into empirical and network models.

2.2.1 Empirical models

The empirical models are based on collected data and regression analysis. They do not explicitly identify the important factors that affect infiltration. The most common empirical models to predict infiltration rate are:

1. Reduction Pressurization Test
2. Regression Technique
3. ASHRAE model

2.2.1.1 Reduction pressurizing test

This is the most widely used method. The infiltration is estimated from pressurization test data. It can be calculated in two ways: single point method and multipoint point method. In the single point method, the air flow rate required to pressurize the building at 50 Pa is measured. Dividing this flow rate by 20 gives the average infiltration rate:

$$Q = \frac{Q_{50}}{20} \quad \text{eqn(7)}$$

where Q_{50} is leakage at 50 Pascal pressure difference and Q is infiltration. This model gives the average infiltration rate. Flow rate is not dependent on the driving force.

In a multipoint method, Blower Door Test is performed at a different pressure difference and power law is used to extrapolate for a particular pressure. The reduction pressurization test is however, not applicable to measure ACH in real time since the building has to be pressurized.

2.2.1.2 Regression Technique

Pressurization data was incorporated with the driving source to fit the data. The leakage is given as (Awbi, 2003):

$$Q = a + b\Delta T + cv^2 \quad \text{eqn(8)}$$

where T is temperature, v is wind speed, and a , b and c are parameters obtained from fitting the data. This method is not reliable because it does not consider the impact of wind direction and shielding effect.

2.2.1.3 ASHRAE model

ASHREA infiltration model is an over simplified equation that combines the wind and stack pressure in the infiltration equation. This model tries to include the effect of the building type and shielding effect. The impact of wind direction is not considered in this model. The modeled infiltration (Q) is given as:

$$Q = A\sqrt{(f_s\Delta T + f_wv^2)} \quad \left[\frac{m^3}{h}\right] \quad \text{eqn(9)}$$

where, A is leakage area, f_s is stack coefficient, f_w is wind coefficient, and v is weather station wind speed. The value of the stack and the wind coefficient is given in Tables 3 and 4 .

Table 3: Stack coefficient

Building type	Stack coefficient (f_s)
One store	0.00188
Two-stores	0.00376
Three-stores	0.00564

Table 4: Wind coefficient: wind shielding factor

Shielding class	Building wind coefficient (f_w)		
	One-story	Two-story	Three - story
No local shielding	0.00413	0.00544	0.00640
Light local shielding (few obstruction)	0.00319	0.00421	0.00495
Moderate local shielding (other building with similar height)	0.00226	0.00299	0.00351
Heavy Shielding (tall building , suburb)	0.00135	0.00178	0,00209
Very Heavy shielding (urban area)	0.00041	0.00054	0.00063

2.2.2 Network Air infiltration model

These models are physics based models. They are categorized as a single zone model and multi-zone model. According to ASTM E779-10 (ASTM E779-10, 2010), a single zone is defined as aggregated space in which the pressure differences between any two spaces in the aggregation is less than 5% of the inside-outside pressure difference. In a single zone model, the internal condition of the building is assumed to be homogenous. The accuracy of the single zone method is around $\pm 25\%$ (Awbi, 2003). The whole house is considered as single zone. A multi-zone model is applied for well-defined building zones. As the purpose of this study is to develop a relative simple and easy to use approach to quantify the average air change rate of the whole house, we limited the study scope to single zone models.

The wind induced infiltration and stack induced infiltration are calculated separately and combined using superposition. Based on how the wind and stack pressure induced infiltration calculated, a single zone model is classified as (Awbi, 2003):

1. Building Research Establishment model (BRE)
2. Lawrence Berkeley Laboratory model (LBL)
3. Alberta –infiltration model (AIM-2)

2.2.2.1.1 Building Research Establishment Model (BRE)

The BRE model predicts infiltration in the naturally ventilated houses induced by wind and stack. The wind and stack induced infiltrations are calculated separately and are then combined to determine the total infiltration rate:

$$Q = \sqrt{Q_w^2 + Q_s^2} \quad \text{eqn(10)}$$

where, Q is total infiltration, Q_w is wind induced infiltration, and Q_s is stack induced infiltration.

The wind induced infiltration (Q_w) and the stack induced infiltration (Q_s) are calculated by:

$$Q_w = C [\rho v^2]^n f_w(\theta) \quad \text{eqn(11)}$$

$$Q_s = C \left[\frac{\Delta T \rho g h}{T_{in}} \right]^n f_s \quad \text{eqn(12)}$$

where, C is the building leakage characteristic constant, n is the building leakage exponent, ρ is air density, v is wind velocity, f_w is wind factor, and f_s is stack factor. T_{in} is the indoor air temperature, ΔT is the inside and the outside air temperature difference, g is gravitational acceleration, and h is the building height.

The building leakage characteristic constant (C) and the building leakage exponent (n) are determined from building pressurization test. The values of wind factor (f_w) and stack factor (f_s) are given in Table 5 below. The wind factor is determined as a function of building type, building leakage exponent, and wind direction.

Table 5: Values of stack and wind factors for BRE model (Awbi, 2003)

House type	n	F_s	$F_w(0 \text{ deg wind})$	$F_w(90 \text{ deg wind})$	$F_w(270 \text{ deg wind})$
Detached	0.5	0.26	0.17	0.20	
	0.6	0.23	0.15	0.18	
	0.7	0.2	0.13	0.16	
Semi-detached	0.5	0.26	0.16	0.18	0.12
	0.6	0.23	0.15	0.16	0.10
	0.7	0.20	0.14	0.15	0.08
Centre terrace	0.5	0.26	0.20	0.13	
	0.6	0.23	0.18	0.10	
	0.7	0.20	0.16	0.08	

2.2.2.1.2 Lawrence Berkeley Laboratory model (LBL)

Sherman and Grimsrud (1980) introduced LBL model. Like the BRE model, the wind induced and the stack induced infiltration rates are calculated separately and combined using a simple quadratic superposition shown below:

$$Q = \sqrt{Q_w^2 + Q_s^2} \quad \text{eqn(13)}$$

where Q is the total infiltration, Q_w is wind induced infiltration, and Q_s is stack induced infiltration.

Wind induced infiltration is calculated based on wind speed and leakage area as shown below:

$$Q_w = f_w A_e v \quad \text{eqn(14)}$$

where, A_e is the effective leakage area and f_w is wind factor , and v is the wind speed.

Effective leakage area (A_e) is defined as:

$$A_e = \frac{C(\Delta P_{ref})^n}{\sqrt{2\Delta P_{ref}/\rho}} \quad \text{eqn(15)}$$

where ΔP_{ref} is the reference pressure, ρ is outdoor air density, C is the building leakage characteristics , n is the building leakage exponent.

The building leakage characteristic (C) and exponent (n) are determined from the Blower Door Test. The reference pressure is usually considered as 4 Pa.

The effective leakage area is a sum of ceiling leakage area (A_c), floor leakage area (A_f), and wall leakage area(A_w) . They are used to determine wind and stack factors in this model.

$$A_e = A_c + A_f + A_w \quad \text{eqn(16)}$$

Further, the building leakage parameters X and R are defined based on the leakage distribution as follows:

$$R = \frac{A_c + A_f}{A_e} \quad eqn(17)$$

$$X = \frac{A_c - A_f}{A_e} \quad eqn(18)$$

The wind factor (f_w) is one of the parameters used to calculate the wind induced infiltration. It is defined as:

$$f_w = k^3 \sqrt{(1 - R)} \left[\alpha \left(\frac{H}{10} \right)^\gamma / \alpha' \left(\frac{H'}{10} \right)^{\gamma'} \right] \quad eqn(19)$$

where k is shield coefficient, α and γ are terrain parameters at the building, H is the building height, H' is the height where the wind measurement is taken, and α' and γ' are the terrain parameters at the weather station. R is the sum of leakage fraction defined in *eqn(17)*.

The value of the terrain parameters (α and γ) and generalized shielding coefficient (k) are given in Table 6 and Table 7, respectively.

Table 6: Terrain parameter (Sherman and Grimsrud, 1980)

Terrain description	α	γ
Ocean or body of water	0.1	1.3
Flat terrain with some isolated obstacle e.g. Building and trees well separated from each other	0.15	1
Rural area with low buildings, trees, etc.	0.2	0.85
Urban , industrial or forest areas	0.25	0.67
Centre of large city	0.35	0.47

Table 7: Generalized Shielding Coefficient (Sherman and Grimsrud, 1980)

Description	k
No obstructions	0.34
Light local shield with few obstruction	0.3
Moderate local shielding , some obstruction within two house heights	0.25
Heavy shielding , obstruction around most of the perimeter	0.19
Very heavy shielding , large obstruction surrounding perimeter within two house heights	0.11

The stack-induced infiltration is given as:

$$Q_s = f_s A_e \sqrt{\Delta T} \quad \text{eqn(20)}$$

where f_s is stack factor, A_e is the effective leakage area and ΔT is the indoor and the outdoor temperature difference.

For buildings whose neutral pressure level is not known, the stack factor is given as:

$$f_s = \left[\frac{(1 + 0.5R)}{3} \right] \cdot \left[1 - \left(\frac{X^2}{(2 - R)^2} \right) \right] \sqrt{\frac{gH}{T_i}} \quad \text{eqn(21)}$$

where g is gravitational acceleration, T_i is the indoor air temperature, and H is the building height. R and X are the building leakage fractions defined in *eqn(17)* and *and eqn(18)* respectively.

When building has a known neutral pressure height, the stack factor (f_s) is given as:

$$f_s = \left[\frac{(1 + 0.5R)}{3} \right] \cdot \left[\frac{\sqrt{8Z(1-Z)}}{\sqrt{Z} + \sqrt{1-Z}} \right] \sqrt{\frac{gH}{T_i}} \quad \text{eqn(22)}$$

where R is the leakage fraction (*eqn(17)*), g is gravitational acceleration, T_i is the indoor temperature, H is the building height and Z is the neutral pressure line fraction.

The neutral pressure line fraction is defined as:

$$Z = \frac{H_{npl}}{H} \quad \text{eqn(23)}$$

where H_{npl} is the neutral pressure line and H is the building height.

2.2.2.1.3 Alberta –infiltration model (AIM-2)

In 1990, Walker and Wilson developed Alberta air infiltration model (AIM-2) based on the stack and wind effect (I. S. Walker and Wilson, 1990) . Unlike the BRE and LBL models, the interaction of the stack and the wind effects is considered in this model. AIM-2 model is given as:

$$Q = \left(Q_s^{\frac{1}{n}} + Q_w^{\frac{1}{n}} + B(Q_s Q_w)^{\frac{1}{2n}} \right)^n \quad eqn(24)$$

where Q is total infiltration, Q_s is infiltration due to the stack effect, Q_w is infiltration due to the wind effect, B is the interaction coefficient (B= -0.3), and n is the building leakage exponent

The building leakage characters coefficient (C) and exponents (n) are important inputs and obtained from Blower Door Test. The interaction coefficient (B) can be assumed to be -0.3.

Before defining each term in the AIM-2 model given above, it is important to introduce the leakage fraction parameters.

The total building leakage characteristic coefficient is a combination of leakage characteristics of the wall, the floor, the ceiling, and the flue as shown below:

$$C = C_c + C_f + C_w + C_{flue} \quad eqn(25)$$

where C_c , C_f , C_w , and C_{flue} are the leakage characteristics of the ceiling, the floor, the wall, and the flue, respectively. If the building does not have a flue leakage, C_{flue} is zero.

The leakage fraction parameters are define as:

$$R = \frac{C_c + C_f}{C} \quad eqn(26)$$

$$X = \frac{C_c - C_f}{C} \quad eqn(27)$$

$$Y = \frac{C_{flue}}{C} \quad eqn(28)$$

where R is the sum of leakage fraction, X is the subtraction of leakage fraction, and Y is the flue leakage fraction .

Infiltration induced by the stack effect is given as:

$$Q_s = C f_s P_s^n \quad eqn(29)$$

where C is the total building leakage coefficient, n is the building leakage exponent, fs is the stack effect factor, and P_s is the pressure induced by stack effect.

The pressure difference created by the stack effect is given as :

$$P_s = \rho_o g h \left(\frac{T_i - T_o}{T_i} \right) \quad eqn(30)$$

where ρ_o the outdoor air density, g is gravitational acceleration, h is the ceiling height of the upper most story, T_i is the indoor temperature, and T_o the outdoor temperature.

The Stack flow factor (f_s) is derived from leakage characteristics of the building and defined as:

$$f_s = \left(\frac{1 + nR}{n + 1} \right) \left(\frac{1}{2} - \frac{1}{2} (M)^{\frac{5}{4}} \right)^{n+1} + F \quad \text{eqn(31)}$$

where

$$M = \frac{(X + (2n + 1)Y)^2}{2 - R}$$

$$F = nY(Z - 1)^{\frac{3n-1}{3}} \left(1 - \frac{3(X_c - X)^2 R^{1-n}}{2(Z + 1)} \right)$$

$$X_c = R + \frac{2(1 - R - Y)}{n + 1} - 2Y(Z - 1)^n$$

$$Z = \frac{H_{npl}}{H}$$

H_{npl} = neutral pressure line

H = building height

n = building leakage exponent

R = sum leakage fraction

X = subtraction of leakage fraction

Y = flue leakage fraction

The Infiltration induced by the wind effect is given by:

$$Q_w = C f_w P_w^n \quad \text{eqn(32)}$$

where C is the building leakage characteristic, n is the building leakage exponent, f_w is the wind factor, and P_w is the wind pressure.

Pressure induced from the wind is given as:

$$P_w = \rho_o \frac{(C_s v)^2}{2} \quad \text{eqn(33)}$$

where C_s is the wind shelter effect in wind direction, ρ_o is the outdoor air density, and v is wind speed.

The shelter effect coefficient is given in Table 8 below.

Table 8: Wind Shelter Coefficient (Walker and Wilson, 1990)

Shelter coefficient C_s	Description
1.0	No obstructions or local shielding
0.9	Light local shielding with few obstructions within two house heights
0.7	Heavy shielding, many large obstructions within two house heights
0.5	Very heavy shielding, many large obstructions within one house height
0.3	Complete shielding, with large buildings immediately adjacent

For homes with crawlspace, the wind factor is calculated as:

$$f_w = 0.19(2 - n) \left(1 - R \left(\frac{n}{2} - 0.2 \right) \right) \left(1 - \left(\left(\frac{X - 0.2(1 - R - 1.5Y)}{2} \right)^2 \right)^{0.75} \right)$$

eqn(34)

For houses with basement foundation or slab on the ground, the wind factor is given as:

$$f_w = 0.19(2 - n) \left(1 - \left(\frac{X - R}{2} \right)^{1.5-Y} \right) - \frac{Y}{4} \left(\frac{X + R + 2Y}{2} - 2Y \left(\frac{X + R + 2Y}{2} \right)^4 \right)$$

eqn(35)

where n is the building leakage exponent, R is the sum of leakage fraction, X is the subtraction of leakage fraction, and Y is the flue leakage fraction.

2.2.3 Comparison of LBL, AIM-2 and BRE model

LBL, AIM-2, and BRE models are physics based models that are developed from the driving forces of wind and stack. The stack induced infiltration rate and the wind induced infiltration are calculated separately and then combined. The major differences of the three models are summarized below:

1. LBL and BRE use simple quadratic superposition method to combine stack and wind induced infiltrations, while AIM-2 has additional term representing the interaction between wind and stack effects.
2. BRE uses overall leakage characteristics. LBL and AIM-2 models distributed the leakage to the floor, the ceiling, and the wall.

3. Flue factors can be treated separately only in the AIM-2 model.
4. AIM-2 includes the effect of crawl space, basement, and flue, while LBL and BRE models do not.

2.2.4 Drawbacks of existing infiltration models

The empirical models lack precision unless the model coefficients are determined from the air-tightness test for the specific house of interest. They do not consider important factors like shield, terrain and wind direction. The physics based models, LBL and AIM-2, require building blower door test to determine the air leakage characteristics which is expensive and require skill. It is also difficult to measure the stack factor and the wind factor which are unique for each building and its surroundings. Most models used standard tabulated factors to estimate the values based on the qualitative approach. This will lead to large error. The leakage characteristics are assumed to be uniformly disturbed, which is not accurate. Walls with windows and doors tend to have higher leakage than the others. Visual inspection of the distribution of the leakage to the ceiling, floor, and wall was used in AIM-2 and LBL which could cause an error.

2.3 Air Change Rate and Building Leakage Characterization Measurement

Understanding the air change rate is important for predicting the energy loss due to infiltration. McWilliams (2002) reviewed different techniques to measure the air flow across envelope. She covered Tracer gas method (constant decay method, constant concentration method, constant injection method, and pulse injection), fan pressurization, AC pressurization, infrasonic impedance, acoustic technique, and quantified thermography. Claesson and Mattsson (2007) proposed a transient pressurizing method to measure air leakage. Fan pressurization and tracer gas methods are the standard and widely used methods for measuring ACH. They are defined in ASTM standard E779-10 and E741-11, respectively. The available ACH measurement techniques are presented below.

2.3.1 Air pressurization and depressurization

Air pressurization and depressurization method, also known as the Blower Door Test, is the easiest and commonly used in building physics to estimate the air leakage in the building and/or to characterize the building envelope system. The measurement is done using a blower or fan, a differential pressure measurement device and an air flow meter. The building is pressurized /depressurized and kept at a certain pressure. Using mass balance concept, the amount of air pumped in the building to pressurize the building is assumed to be the leakage rate at that particular pressure difference across the envelope. Pressurization and depressurization might not give the same

result since the flow path is different (Shaw, 1980). This method is a steady state process and has to be done at stable climate condition (Awbi, 2003; Shaw, 1980). To avoid the wind and the stack effect, the building is recommended to be pressurized between 10 Pa and 60 Pa. At least five data points are required and the rest of air leakage data are interpolate using the power law (ASTM E779-10, 2010, p. 779). This method has uncertainty of 10% to 13%. If we increase the number of data points, the uncertainty can be reduced to 5.5%(Lordache and Catalina, 2012). According to the ASTM 779-10 standard, this test has to be performed under two conditions. The wind speed has to be less than 1 m/s and the building height multiplied by the indoor/outdoor temperature difference has to be less than 200 m-°C. The disadvantages of this method are:

1. It uses excessive pressure than the natural condition.
2. It cannot be used to measure ACH near real time.
3. The large volume of air pumped into the building can affect the indoor air temperature (Dewsbury, 1996).

According to (Walker et al 1997), the leakage characteristic obtained from the power law can be extended to the low pressure range(0-10 Pa).

2.3.2 Dynamic (AC) pressurization

Dynamic pressurization technique measures a leakage rate as low as 4 Pa pressure difference. Sinusoidal change in building volume produces periodic pressure difference which is related to air leakage. The frequency and the amplitude is affected by the air tightness of the building (Awbi, 2003; Mattsson and Claesson, 2007). No air is pumped into the room so it can keep the room temperature. This method can

measure real time leakage. But this system is less common and only measures leakage at a given pressure. The equipment is more expensive than the blower door test method. It is less dependent on climate condition. (Modera and Sherman, 1985.).

2.3.3 Transient pressurization method

Mathson and Claesson (2007) proposed a new method to measure building air leakage. This method only needs pressure differential measurement. The building is pressurized to a set point and then the air inlet valve is closed. The declining differential pressure across the wall is measured continuously. The measurement has to be taken with high frequency at least 20 times per minute and has to be collected over the entire pressure range. This data uses to determine the building leakage rate. This method is sensitive to wall or envelop deformation. The elasticity nature of the air barriers and insulation materials affects this method(Mattsson and Claesson, 2007).

2.3.4 Tracer gas method

Tracer gas methods are widely used method to measure ACH next to pressurization method. It is the only available method to measure ACH near-real time. The equipment is expensive and requires skilled personnel to perform the measurements. The measurement is performed by injecting tracer gas into the measure room or zone and monitoring the concentration of the tracer gas.

The choice of tracer gas is determined by safety, uniqueness, and measurability. It should not react to any part of the building material. It has to be insensibility for air flow or air density. In the past numerous gases were used in tracer gas method:

Helium (He), hydrogen(H_2), oxygen(O_2), carbon-monoxide (CO), methane (CH_4), nitrous oxide (N_2O), acetone, sulphur hexafluoride(SF_6), carbon dioxide (CO_2), radioactive noble gases (argon-41 and krypton-85), halogenated hydrocarbons (such as Hexafluorobenzen (C_6F_6), and perfluorocarbons (PFC)(Laussmann and Helm, 2011; Shaw, 1984) . Due to safety and health related issues H_2 , O_2 , CH_4 , CO, N_2O and radioactive noble gases cannot be used in the presence of occupants. SF_6 and halogenated hydrocarbons have ozone depletion potential. They are forbidden in some countries and some states in the US like California. (Sherman, 1990)

Using CO_2 as a tracer gas has advantages and disadvantages. CO_2 is less harmful. A reasonably priced device easily detects this gas. The main disadvantage is that the human CO_2 generation rate varies based on the number of occupants, their age, sex, and activities. The presence of living things contaminates the measurement. The other disadvantage is that the outdoor concentration could be varying between 350-450 ppm or more. (Laussmann and Helm, 2011)

Different studies were made to understand the effect of tracer gas choice on the accuracy of air measurement. Most of the research showed that CO_2 overestimate the air change rate measurement and SF_6 underestimated it. Table 8 presents the previous studies. The ACH ratio measured using CO_2 and SF_6 varies between 0.8 to 1.02.

Table 9: Effect of tracer gas choice.

	$\frac{ACH_{CO_2}}{ACH_{SF_6}}$	Std. Dev.	Method
Riffat (Riffat, 1991)	0.794	Not available	Decay method
Shaw (Shaw, 1984)	1.1	Not available	Decay method
Laussman and Helm (Laussmann and Helm, 2011)	1.021	0.08	

The four standard tracer gas methods to estimate the air change rate are:

1. Decay method
2. Constant concentration method
3. Constant injection method
4. Pulse method and

2.3.4.1 Decay method

The decay method is applicable for air tight buildings. It is commonly used for a steady flow. The equipment is less expensive compared to the other tracer gas methods. The test is performed by injecting a certain amount of tracer gas into the building with a well mix condition. The concentration of the tracer gas decays through time. The tracer gas concentration is measured for a given time. Then ACH rate is derived from the following equation.

$$C_t = C_{t_0} e^{-N t} \quad \text{eqn(36)}$$

where C is the tracer gas concentration, C_0 is the tracer gas initial concentration, t is time and N is Air change rate.

2.3.4.2 Constant Injection method

The constant injection method is applicable to leaky space. The flow has to be steady. A constant amount of tracer gas is injected into the sample space and the injection rate and concentration are measured. From that we derive the ACH from the following equation.

$$C_t = \frac{G_t}{Q} (1 - e^{-Nt}) \quad \text{eqn(37)}$$

where G_t is the tracer gas injection rate, Q is flow rate, t is time and N is Air change rate.

2.3.4.3 Constant concentration method

The constant concentration method may apply for varying ventilation with unsteady flow measurement. This method is more complex than the other tracer gas method. It requires skilled labor and advanced equipment. The equipment is connected to the tracer gas. The tracer gas concentration in the sample space is measured continuously. The equipment injects a certain amount of tracer gas through time to keep a constant concentration. The equipment has a sophisticated control system to perform this test. From the collected data the air change rate is calculated as:

$$G_t - VNC_t = 0 \quad \text{eqn(38)}$$

where V is volume, G_t is the tracer gas injection rate, C_t is the tracer gas concentration, and N is air change rate.

2.3.4.4 Pulse injection

A certain amount of tracer gas is delivered to the zone and sample where taken some distance away from the injection point. The measurement period started before injecting the tracer gas. This technique is similar to the decay method except the amount of tracer gas injected is measured. This technique is applicable for single or multi-zone.

2.3.5 Acoustic Method

Lordache and Catalina (2012) developed a new method to measure air infiltration using acoustics. A noise generator and two sonometers are used for the experiment. The noise generator produces sound. The two sonometers record the sound transmission loss between the indoor and outdoor environment. Sound transmission loss is related to air infiltration. The error of this measurement is around 5%. The method is less expensive than the classical pressurization test. It can be done by short time. This method is not yet accepted as a standard method and cannot be used for continuous ACH measuring.

2.4 Existing near-real time ACH measurements drawbacks

Constant concentration tracer method is the only current acceptable method to measure near real time ACH. Most of the tracer gasses used for this method are either toxic or hazardous for human health (CO , N_2O etc) and/or have global warming or ozone depletion potential. CO_2 under a certain concentration level is the preferable gas to use for near-real time monitoring for occupied building. The downside of using CO_2 as a tracer gas is that the measurement could be affected by the CO_2 generated by leaving thing in the test area. The outdoor concentration varies by season and hour of the day. This method is expensive and requires skilled labor to perform the measurement.

3 COMBINED IAQ MONITORING AND MODELING METHOD TO DETERMINE ACH NEAR REAL-TIME

3.1 Introduction

AIM-2 and LBL infiltration models are relatively more accurate physics based models to predict infiltration rate induced by the wind and the stack effect. But they could give error up to 100% (Lordache and Catalina, 2012). The main challenge is to predict the stack factor, wind factor, the terrain effect, the shield effect and the building leakage characteristics. The blower door test is commonly used to determine the leakage characteristics and the other factors are obtained from generalized tables based on qualitative prediction. But these factors are building specific. The accuracy of the model is heavily dependent on getting these parameters correct. In this chapter, a new methodology is developed to determine the ACH rate in near-real time by combining the tracer gas method with infiltration model. The infiltration models are modified to include the impact of the wind direction on the local wind speed. The assumptions and limitations of the methodology are discussed in detail. This methodology is designed to be applicable for naturally ventilated occupied buildings with a low cost device and unskilled personnel.

3.2 Assumption and limitation

3.2.1 Single zone model

Determining ACH from the Tracer gas method is derived from the mass balance equation for a single zone. A single family house can be considered as a single zone if there is no restriction between the rooms. This can be achieved by leaving the room doors open.

3.2.2 Well mixed condition

The mass balance equation is also developed under the assumption of a well-mix condition, which means the air quality throughout the zone is assumed to be the same. In the single family house, running a circulation fan could create a well-mixed condition.

3.2.3 Measuring fluctuating ventilation using tracer gas decay method

The decay method is usually used to measure ACH for steady flow rate. This method can be used to measure unsteady flow rate if the tracer gas concentration is measured at a sufficiently high frequency.

3.2.4 CO₂ as a tracer gas

CO₂ gas is easily accessible and inexpensive. Carbon dioxide sensors are relatively inexpensive. But it has the following disadvantages:

1. The outdoor air contains CO₂ gas.
2. The outdoor CO₂ concentration could vary over time.

3. The tracer gas measurement can be contaminated by the presence of living organisms.

The following caution should be taken when using CO_2 as a tracer gas

1. The tracer gas decay method should be performed when the concentration of the room is above 100 ppm from the background concentration.
2. The rate of change of the outdoor of CO_2 concentration is very low compare to the rate of change of indoor concentration. For this reason, the outdoor CO_2 concentration can be taken as constant.
3. The tracer gas decay experiment should be performed in the absence of any additional CO_2 sources in the test area.

3.3 Modified Infiltration Models

AIM-2 and LBL models are discussed in the Chapter 2 in detail. Both models are based on the driving forces: wind and the stack effect. AIM-2 model also incorporates the interaction of the stack and wind induced infiltration. Table 10 presents the summary of these models.

Table 10: LBL and AIM-2 model summary

	LBL Model	AIM-2 Model
Total infiltration	$Q = (Q_s^2 + Q_w^2)^{1/2}$	$Q = \left(Q_s^{\frac{1}{n}} + Q_w^{\frac{1}{n}} - 0.3(Q_s Q_w)^{\frac{1}{2n}} \right)^n$
Stack Effect	$Q_s = f_s C (4)^n \sqrt{\frac{\rho_o}{8}} \left(gh \left(\frac{T_i - T_o}{T_i} \right) \right)^{1/2}$	$Q_s = f_s C \left(\rho_o gh \left(\frac{T_i - T_o}{T_i} \right) \right)^n$
Wind effect	$Q_w = f_w C (4)^n \sqrt{\frac{\rho_o}{8}} v$	$Q_w = f_w C \left(\rho_o \frac{C_s v^2}{2} \right)^n$

where Q_s and Q_w are infiltrations induced by stack effect and wind effect respectively. C is the total building leakage coefficient, n is the building leakage, f_s is the stack effect factor, f_w is the wind factor, g is gravitational acceleration, h is building height, T_i are the indoor temperature, T_o the outdoor temperature, ρ_o is the outdoor air density, and v is wind speed from the weather station.

One of the drawbacks of the LBL and AIM-2 models is the assumption that wind direction has no significant impact on the wind factor (Walker and Wilson, 1990).

One wind factor is used for all wind direction in these models. Wilson and Walker (1991) indicated that the wind direction has a significant effect on the infiltration rate like wind speed and temperature difference. To get a better understanding of the impact of terrain and surrounding effect on wind speed, comparison was made between the two weather stations. BEST laboratory has a weather station located on top of the building. The data was collected every minute. Another weather data was also obtained from National Oceanic and Atmospheric (NOAA) at Syracuse Airport.

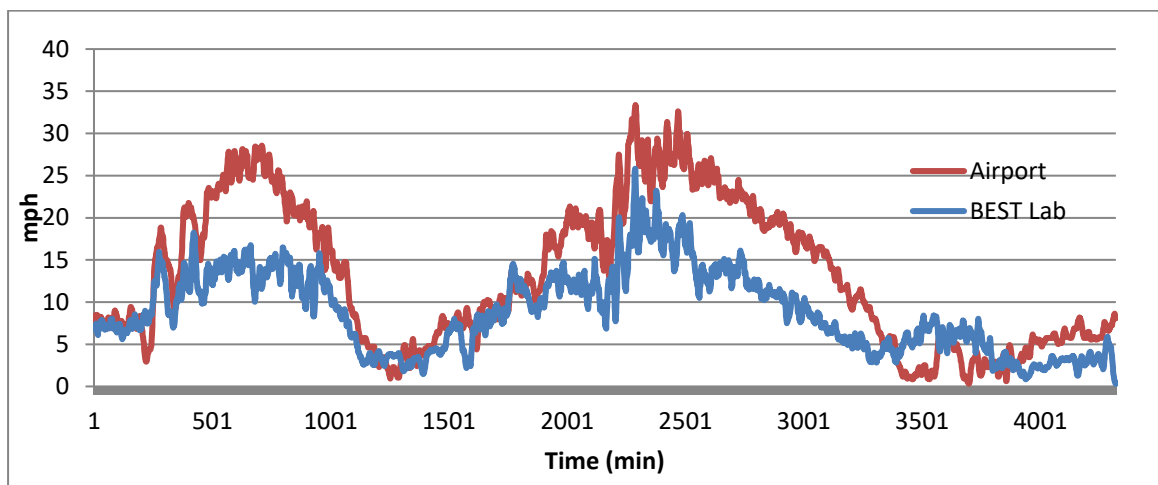

Figure 2: Wind speed

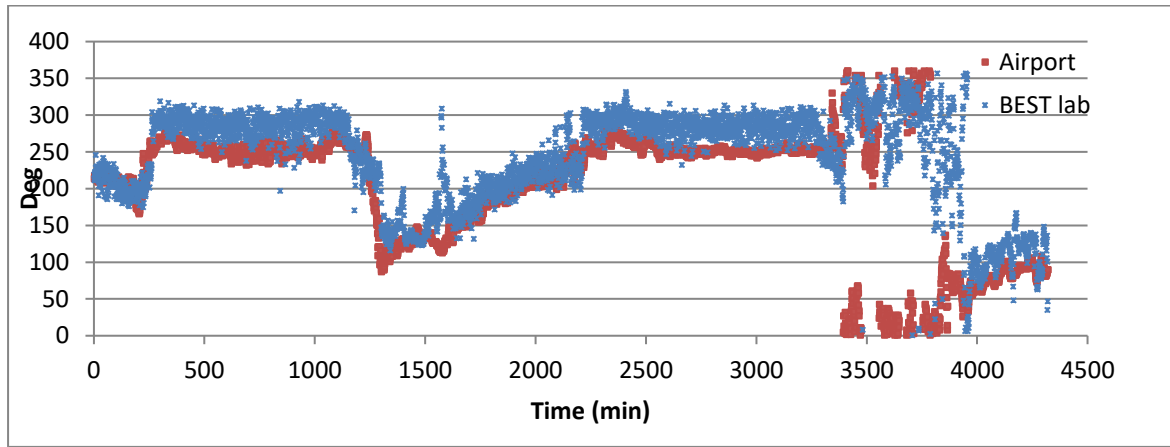

Figure 3: Wind direction

Figure 2 and Figure 3 show the wind speed and the wind direction, respectively. Even if the wind speed trend is the same for both locations, the magnitude is different.

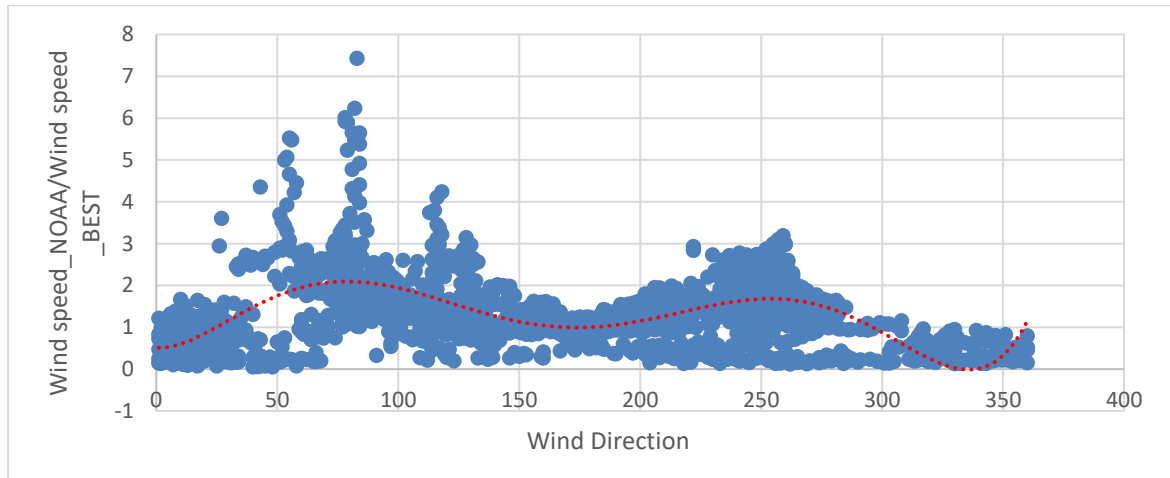

Figure 4: NOAA and BEST wind speed ratio vs wind direction

Figure 4 shows the ratio of the wind speed measured from the site and the wind speed from the airport weather against the wind direction. The higher ratio indicates that there is a greater wind shield effect. The east (Wind direction=90 degree) and the

southwest side of the building (wind direction= 250 deg) have the highest wind shield effect which is expected. The satellite picture shows that the east side of the building is shielded by vegetation. The topography map of the area indicates a hill is located on the west side of the building. The satellite photo and the topography around the test site are presented in next chapter. It is important to note that the wind shield effect is dependent on the wind direction. Taking one shield factor in the standard LBL or AIM-2 model would lead to error.

In this dissertation, a discrete function is used to determine the wind factor (f_w) . It captures the effect of the local condition, such as the terrain and building's surrounding microclimate, as a function of wind direction for the specific building. The wind factor function is given as:

$$f_w = \begin{cases} f1 & \text{where } 0 \leq \phi < 30 \\ f2 & \text{where } 30 \leq \phi < 60 \\ f3 & \text{where } 60 \leq \phi < 90 \\ \vdots & \\ \vdots & \\ f12 & \text{where } 330 \leq \phi < 360 \end{cases} \quad \text{eqn(39)}$$

Where f_w is the wind factor and ϕ is the wind direction. Wind angles 0, 90, 180, and 270 indicate wind blows from north, east, south and west, respectively.

3.4 Tracer gas technique to measure ACH

Determining the ACH from tracer gas technique is derived from conservation of mass in a control volume, like building enclosure system. Conservation of mass of air for a given control volume is given as:(Sherman, 1990)

$$\frac{dm_{in}}{dt} + \dot{m}_{ent} - \dot{m}_{lvg} = G_a \quad eqn (40)$$

where $\frac{dm_{in}}{dt}$ is the rate of change of mass inside the control volume, \dot{m}_{ent} is mass flow rate entering control volume, \dot{m}_{lvg} is mass flow rate leaving the control volume and G_a is air generation rate inside the volume.

Mass in the control volume is defined as:

$$m = \rho V \quad eqn (41)$$

where ρ is density and V is volume.

Mass flow rate is given as:

$$\dot{m} = \rho Q \quad eqn (42)$$

where \dot{m} is mass flow rate, Q is volume flow rate and ρ is density.

Substituting the above two equations in eqn (40) gives:

$$\frac{d(\rho V)_{in}}{dt} + \rho_{ent} Q_{ent} - \rho_{lvg} Q_{lvg} = G_a \quad eqn (43)$$

For the building enclosure system, the following assumption are taken:

1. The building enclosure system is rigid. V is constant.
2. Air is assumed as an incompressible fluid in this study.
3. The outdoor air and the indoor air density difference is assumed to be small in this study ($\rho_{lvg} \approx \rho_{ent} \approx \rho$).
4. There is no other air source in the control volume ($G_a=0$).
5. The building maintains a well mix condition.

Applying these assumptions in *eqn(43)* gives:

$$Q_{ent} = Q_{lvg} = Q \quad \text{eqn (43)}$$

For tracer gas, the mass conservation equation is given as:

$$\frac{d(C_t m)_{in}}{dt} + C_{t_ent} \dot{m}_{ent} - C_{t_lvg} \dot{m}_{lvg} = G_t \quad \text{eqn (44)}$$

Where $\frac{d(C_t m)_{in}}{dt}$ is the rate of change of tracer gas mass inside the control volume, C_{t_ent} is the tracer gas concentration of the air entering the control volume, C_{t_lvg} is the tracer gas concentration of the air exiting the control volume, \dot{m}_{ent} is mass flow rate of air entering control volume, \dot{m}_{lvg} mass flow rate air leaving the control volume and G_t is tracer gas generation rate inside the volume.

Substituting *eqn (40)* and *eqn (41)* in *eqn (44)* gives:

$$\frac{d(C_t \rho V)_{in}}{dt} + C_{t_ent} Q_{ent} \rho_{ent} - C_{t_lvg} Q_{lvg} \rho_{lvg} = G_t \quad \text{eqn(45)}$$

Combining eqn (43) and eqn (45) gives:

$$\frac{d(VC_t)_{in}}{dt} + Q(C_{t_{ent}} - C_{t_{lvg}}) = \frac{G_t}{\rho} \quad \text{eqn (46)}$$

The entering concentration, $C_{t_{ent}}$, is same as outdoor air concentration ($C_{t_{out}}$). For a well mix condition, the leaving air concentration ($C_{t_{lvg}}$) is the same as the indoor concentration ($C_{t_{in}}$). From continuous monitoring of the concentration of the tracer gas, we can derive the instantaneous infiltration by discretizing the above equation as follows:

$$V \frac{C_{t_{in}} - C_{t_{in_{i-1}}}}{\Delta t} + Q(C_{t_{out_i}} - C_{t_{in_i}}) = \frac{G_{t_i}}{\rho} \quad \text{eqn (47)}$$

where V is volume of the house; Q is the infiltration rate, $C_{t_{in}}$ is the tracer gas concentration inside the house, $C_{t_{out}}$ is the outside air tracer gas concentration, and G_t is tracer gas generation rate. By monitoring of the pollutant concentration level and the generation rate, it is theoretically possible to determine the infiltration rate from eqn (47) and given as:

$$Q = \frac{1}{(C_{t_{out_i}} - C_{t_{in_i}})} \left(-V \frac{C_{t_{in}} - C_{t_{in_{i-1}}}}{\Delta t} + \frac{G_{t_i}}{\rho} \right) \quad \text{eqn (48)}$$

3.5 Determining near real time ACH by combined infiltration model and tracer gas method

In this dissertation, a different approach is used to measure the infiltration in near real time. A methodology is developed to combine infiltration model (AIM-2 or LBL) with tracer gas method. As shown in Figure 5 below, the methodology has two parts: building calibration and monitoring. The first step of this methodology is to calibrate the building to determine the infiltration model parameters: the wind factor, the stack factor and the building leakage characteristics. Nonlinear multi-variable regression is applied to the AIM-2 or LBL infiltration models to determine these parameters instead of Blower test and tabulated data. The input variables for the regression are ACH from the tracer gas method, indoor air temperature, outdoor air temperature, and wind speed and wind direction. Sufficient data is required to get a better result. The tracer gas method and regression technique are only required for calibration. Once the parameters are determined, using real time indoor temperature, outdoor temperature, wind speed, and wind direction in the infiltration model gives near real-time ACH for naturally ventilated houses with a better accuracy.

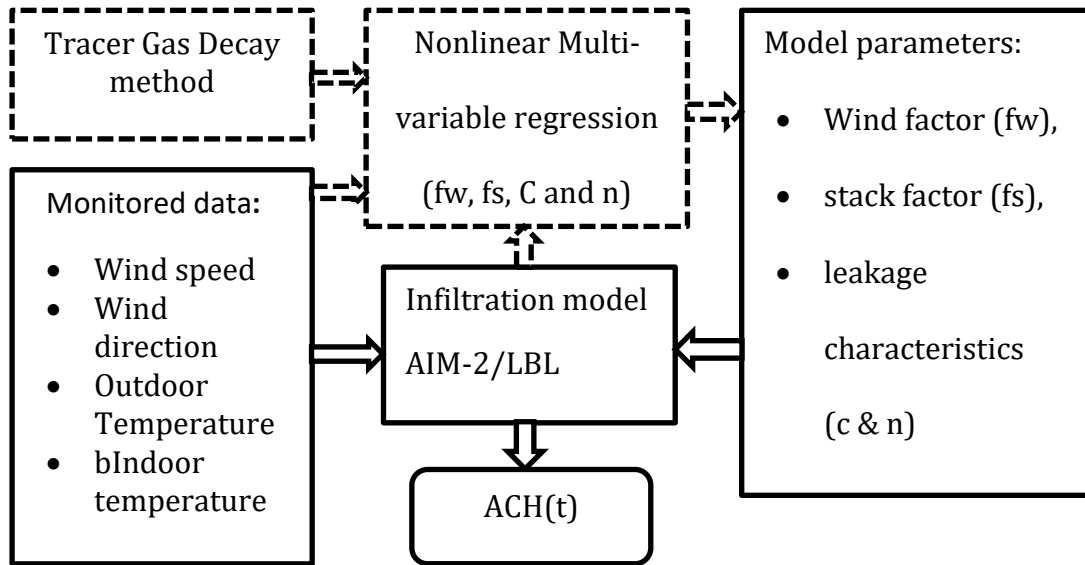

Figure 5: Methodology to determine ACH near real time using tracer gas and weather data in the infiltration model

Preparing the house for a tracer gas decay test is the starting point to determine the infiltration model parameter. The calibration should be done in the absence of occupants or living things. All door and windows should be closed. The indoor air temperature is measured every minute. The weather data (temperature, wind speed and wind direction) for every minute is obtained from a nearby weather station. For this study, the National Oceanic and Atmospheric Administration (NOAA) weather data collected at Syracuse airport was used. A well mix condition is created inside the house by running the circulation fan continuously. The next step is to apply tracer gas method to determine the infiltration rate. CO₂ is injected until it reaches 1200 ppm. This tracer gas concentration limit is set based on CO₂ sensor capacity. It can be injected in the return duct or after the circulation fan. The CO₂ concentration is measured every minute. For leaky house the infiltration rate is higher. The tracer gas

decays faster and reaches the outdoor CO₂ concentration before collecting enough data to do the regression. For this kind of situation, the tracer gas is injected again when the room CO₂ level reaches 600 ppm. The data collected from the BEST laboratory indicates that the outdoor CO₂ concentration is between 360 to 380 ppm. It is important to note that the presence of CO₂ in the background would affect the ACH measurement. The impact is discussed in the next chapter. From the CO₂ concentration data, ACH is determined for every minute.

Once the weather data, the infiltration rate and the room temperature are known for every minute, nonlinear multi-variable regression technique is used to determine the infiltration model parameters. The regression variables, which are also the infiltration model parameters, are:

1. Building leakage characteristic constant , C
2. Building leakage exponent, n
3. Wind factor, f_w
4. Stack factor, f_s

To get valid results from the regression test, it is important to use the following the reasonable constraints based on fundamental physics:

1. Building exponent is between 0.5 and 1, corresponding to fully developed turbulence and laminal flows through leakage openings.
2. The building leakage characteristic (C) is always great than 0.
3. The combined shield and wind factor (f_w) is between 0 and 1.
4. The stack factor (f_s) is between 0 and 1.

Once the infiltration model parameters are determined from the regression, the infiltration of the house is calculated more accurately from the nearby weather data (wind speed, wind direction, the outdoor temperature) and the indoor temperature.

4 EXPERIMENTAL FACILITY AND INSTRUMENTATION

4.1 Test house and location

The experiment was performed in the Building Enclosure System Technology (BEST) laboratory located at Sky top Rd, Syracuse NY. The BEST laboratory is a two story building constructed in 2009 with the collaboration of Oakridge National Lab, Air Barrier Association of America, NYSERDA, and Syracuse University. The building has 41ft length, 33ft width, and 21ft height. It has no internal partitions. The first and second story of the building are connected with a stairway opening. This laboratory was constructed to test a wall assembly air leakage and thermal performance in a real weather condition. The house has thirty-four slots to test wall assemblies at a time.



Figure 6: BEST laboratory

Figure 7 shows the building surrounding. The building north and east sides are shielded by trees. An office building is located in the west side of the test house. The south side has no shield.



Figure 7: Best Lab surrounding (google map)

Figure 8 shows the topographical map of the area. There is a hill on the southwest side of the BEST laboratory building. The elevation difference is around 120 feet. A single story office building is also located in the west side of the laboratory at lower elevation, about 10 feet from BEST laboratory.

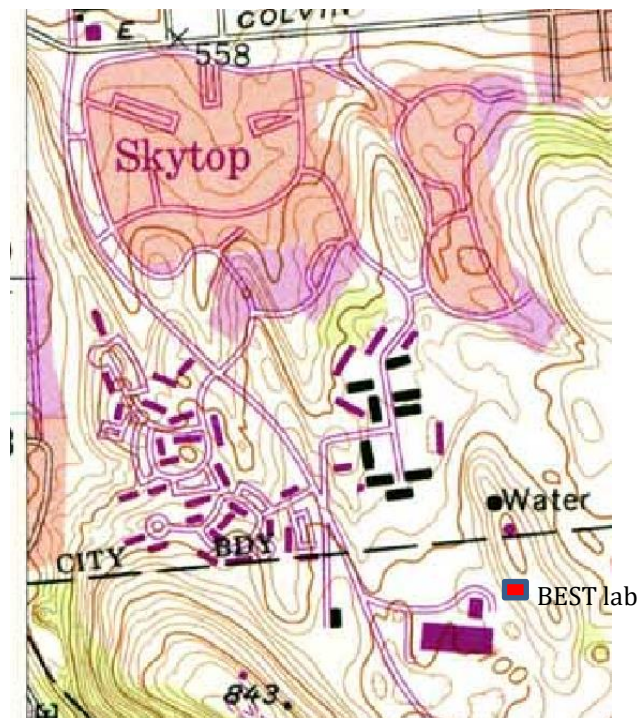

Figure 8: Best lab Topography (<http://nyfalls.com/maps/ny-maps-topo-24000/>)

4.2 Instrumentation

The building has a central air system to cool and heat the house. The circulation system fan can be set to run continuously. The building is also equipped with blower door test equipment. The building has a local weather station to measure the local wind speed, wind direction, humidity, precipitation, and solar radiation.

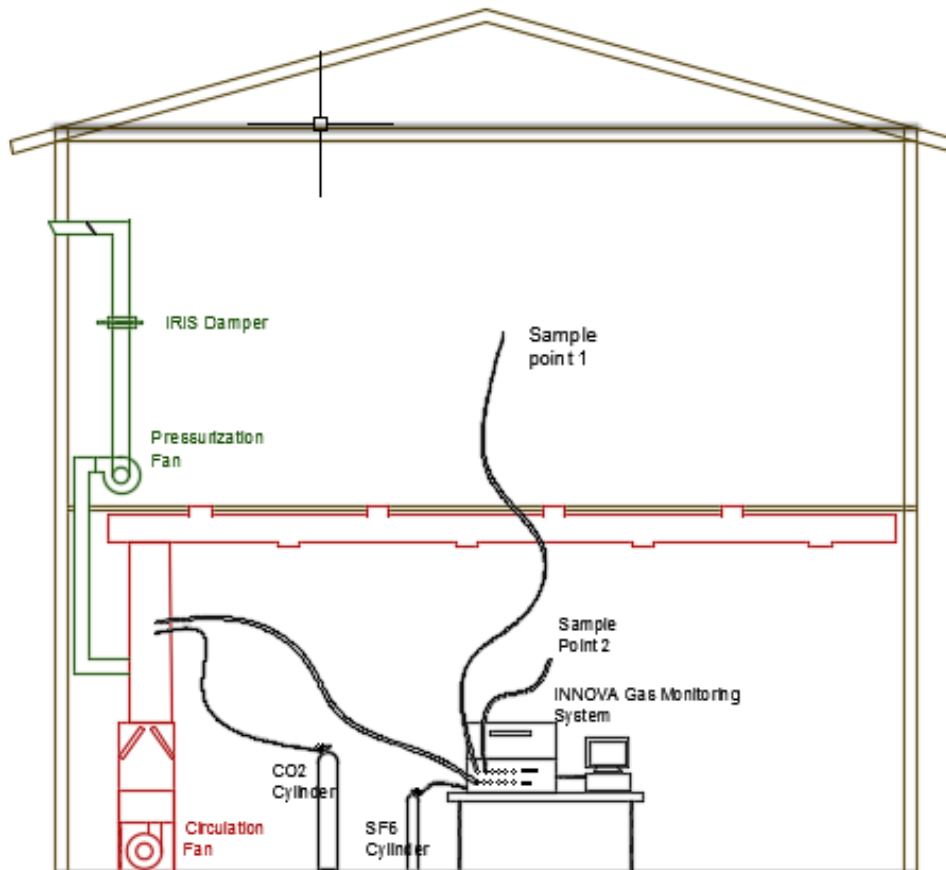

Figure 9: BEST lab equipment and arrangement

Figure 9 shows the laboratory instrumentation inside the building. The experiment setup is designed to perform tracer gas decay method, tracer gas constant concentration method, and blower door test method simultaneously or separately.

INNOVA gas monitoring system is used for the tracer gas method. SF_6 tracer gas was used to perform a constant concentration method test. The SF_6 gas cylinder is directly connected to INNOVA gas monitoring system. The gas monitor injects a certain amount of SF_6 to keep the concentration constant. The tracer gas was injected next to the circulation fan. The fan creates a turbulent air flow that insure a well mix condition. A tube is used to connect the INNOVA gas monitor output to the duct system. The SF_6 concentration and injection rate are measured every minute. The monitoring system has internal build PID control to keep the concentration at a certain level by dosing the necessary amount.

For the Decay method, CO_2 gas was used. The CO_2 cylinder was directly connected to the duct unit right after the circulation fan. After the CO_2 concentration reached a certain level, the valve was closed manually. INNOVA gas monitor is used to measure the CO_2 concentration. Outdoor CO_2 concentration was also monitored. The air samples are collected from three different locations : the first floor, the second floor, and outside of the building.

The building is also equipped to run the blower door test.

The blower fan is installed to the west side of the building. The blower fan speed is controlled by a VFD drive connected to a PID controller. The controller set the fan speed to keep the required pressure difference across the building enclosure. The air flow rate required to keep the pressure difference is measured using an orifice damper. It is installed in the duct before the fan inlet. The correlation between the flow rate and the pressured drop is used to determine the building leakage characteristics.

5 RESULTS AND DISCUSSION

5.1 Introduction

The new methodology to measure ACH measurement near-real time for naturally ventilated house is discussed in chapter 3. In this chapter, experimental results to validate the methodology and its assumptions are presented and discussed.

5.2 Single zone model and well mixed condition

This experiment was designed to validate the well mix condition at residential houses when the circulating fan runs continuously. This assumption only holds true if tracer gas concentrations are similar on the first and second floor for any given time. Both decay and constant concentration tracer gas methods are used for this experiment. CO_2 and SF_6 gases are used for decay and constant concentration tracer gas method, respectively. For decay test, the carbon dioxide gas was injected into the air circulation system after the circulation fan. It is injected until the concentration reaches to 1250 ppm in the house. The CO_2 concentration data was collected through the decay process from the first and second floors. The INNOVA gas monitoring system injected SF_6 gas, at the same location as the CO_2 . The system was set to keep the gas concentration at the 8mg/m³ on the second floor. Samples were taken from both floors.

Figure 10 shows the SF_6 tracer gas concentrations in the first floor and second floor for constant concentration method. The second floor concentration is very close to the setting point, which is 8mg/m³.

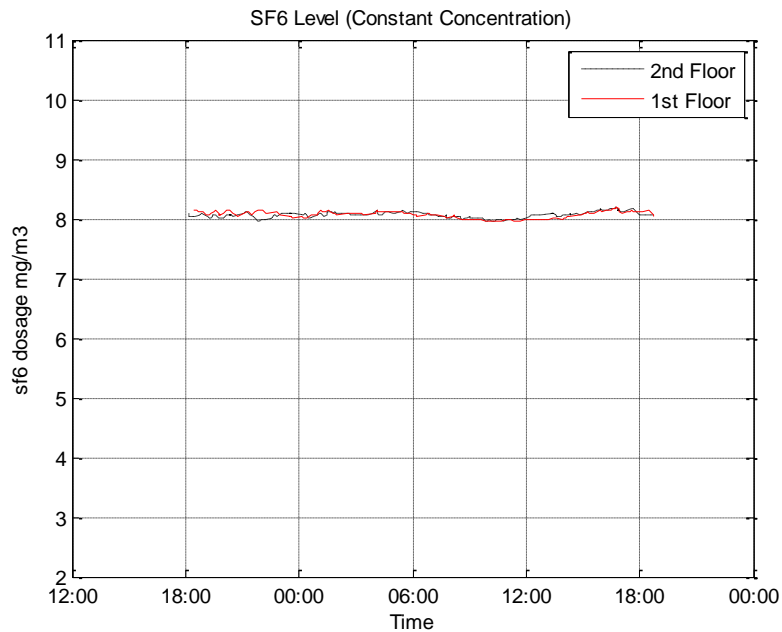

Figure 10: SF6 concentrations on first and second floors

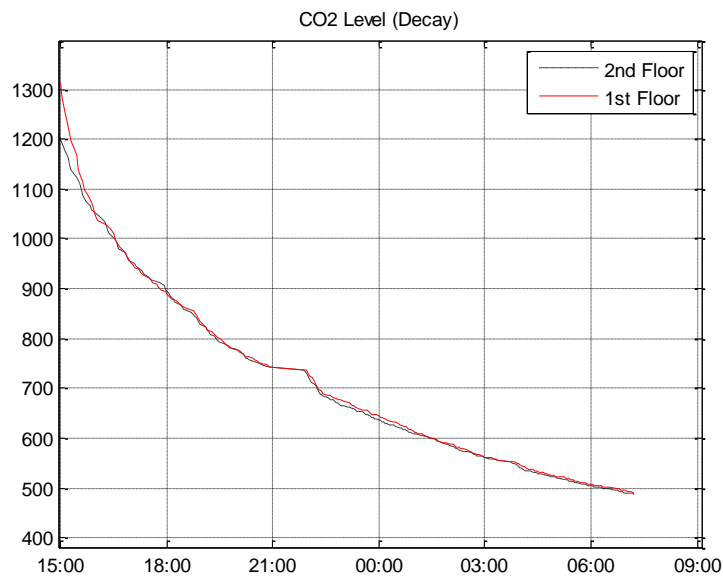

Figure 11: CO2 concentration on first and second floors

Figure 11 presents the concentrations of carbon dioxide in the first and second floor for decay test.

The percentage error was calculated and used to compare the result for both tracer gas methods. The percentage error was calculated as:

$$|\mathbf{Error\%}| = \frac{|(C_{t_{1st}} - C_{t_{2nd}})|}{C_{t_{avg}}} * 100 \quad \text{eqn (49)}$$

where, $|\mathbf{Error\%}|$ = absolute percentage error

$$C_{t_{avg}} = \text{The average room tracer gas average } \left(\frac{C_{t_{1st}} + C_{t_{2nd}}}{2} \right)$$

$C_{t_{1st}}$ = Tracer gas concentration on the first floor

$C_{t_{2nd}}$ = Tracer gas concentration on the second floor

Table 11: The percentage error of tracer gases between the first and second floor

	<i>SF₆</i> gas	<i>CO₂</i> gas
Average error (%)	1.13	0.104
Standard deviation (%)	0.7	0.117

Table 11 shows the error analysis between the first and second floor concentration levels. The calculated percentage errors of the *CO₂* and the *SF₆* gases are less than 0.104% and 1.13%, respectively. From this, it is reasonable to assume that a well mix condition can be maintained by running the circulation fan continuously. It can also be

deduced that the atomic weight difference between the two tracer gases has less impact on the well mix condition.

5.3 Decay method to measure varying ventilation

The decay method is usually used to measure steady air flow and constant concentration method for a varying flow rate. Performing the decay tracer gas method does not require sophisticated equipment and skill labor. It is relatively cheaper compare to the other tracer gas methods. The advancement of the sensor and computer technology enables us to measure the tracer gas concentration at high sampling frequency. Here we tried to use decay method to measure varying ventilation by capturing the tracer gas concentration at reasonable frequency. The CO_2 gas was used as the tracer gas for the decay method. The constant concentration method, SF_6 as a tracer gas, was used as the reference.

This experiment was performed using INNOVA tracer gas system. The data is collected for every minute. The ACH obtained from the two tests are presented in Figure 12 below. The measured air change rate varied from 0.1 to 0.4 1/h. The ACH rate obtained from the decay and constant concentration methods followed the same trend.

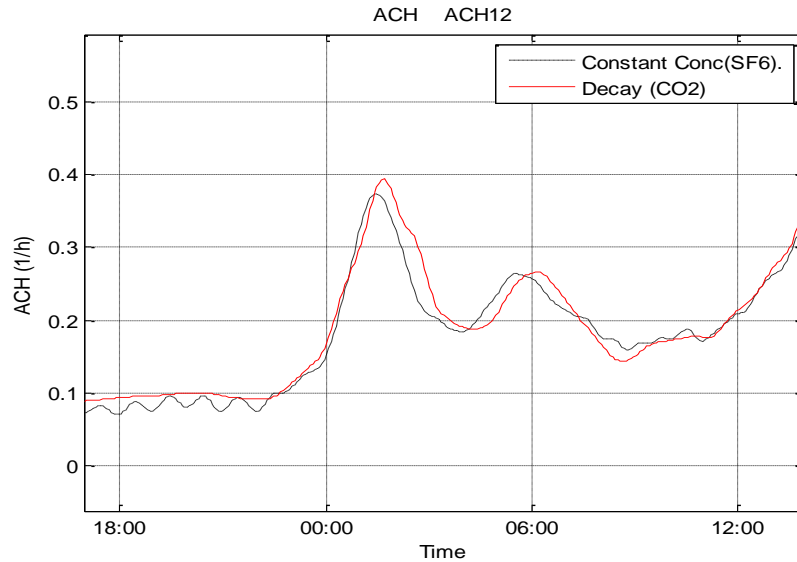

Figure 12: Constant concentration versus constant injection

The error calculation was performed using the following equation:

$$\text{error}\% = \frac{|(ACH_{const} - ACH_{decay})|}{ACH_{const}} * 100 \quad \text{eqn (50)}$$

where, **error**% = percentage error

ACH_{const} = air change rate measure using tracer gas constant concentration tracer gas method

ACH_{decay} = air change rate measure using tracer gas decay method

The absolute average error was 10% with a standard deviation of 7.8. From this result, it is reasonable to assume that the decay method can be used to measure the dynamic ACH for naturally ventilated houses with an uncertainty of $\pm 10\%$ on average.

5.4 The effect of tracer gas in the background

The disadvantage of using CO_2 as a tracer gas is its presence in the background or outdoor air. The impact was investigated in this section. The experiment was performed using the INNOVA gas monitoring system. The fan control was set to run continuously to create the well-mixed condition. CO_2 and SF_6 gasses were used to perform the decay method and constant concentration method. The outdoor CO_2 concentration was also monitored.

Figure 13 presents the CO_2 concentration of the indoor and outdoor air. The outdoor CO_2 concentration fluctuated between 345 to 365 ppm. The indoor CO_2 concentration level decayed from 1100 ppm to 365 ppm. The data was monitored until the indoor concentration reached the outdoor concentration. The rate of change of the outdoor air CO_2 concentration was very small compared to the indoor. It is reasonable to assume that the outdoor CO_2 concentration as constant.

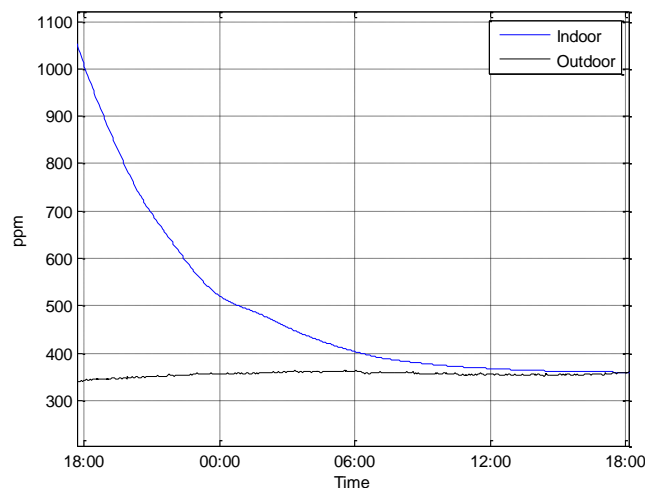

Figure 13: Indoor and Outdoor CO2 Concentration level

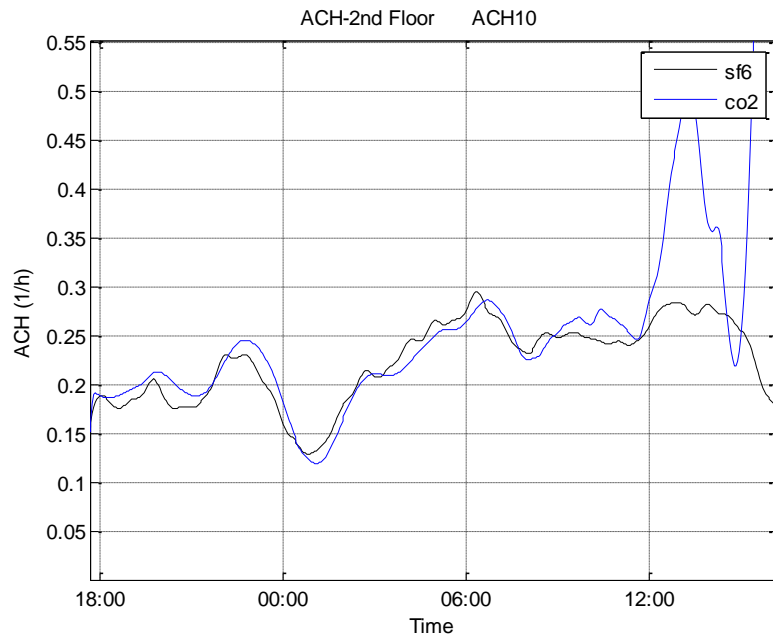

Figure 14: Air change obtained from constant concentration and decay method

Figure 14 shows the ACH obtained from the decay and constant concentration methods. Both methods followed the same trend until it reaches 08:00 time, where the indoor and outdoor CO_2 concentration level difference was around 40 ppm. After this point, the ACH from decay method started to depart from the constant concentration method. From this experiment suggested that the use of decay method with CO_2 is viable when the indoor air concentration is 100 ppm above the background level to be on the safe side.

5.5 Non-linear multi-variable regression technique to determine air leakage characteristics, wind factor and stack factor

A new methodology was introduced in chapter three to determine the ACH by combining the tracer gas method with the AIM2 or LBL infiltration model. The tracer gas method is used to determine the building leakage characteristics, the stack factor, and the wind factor using nonlinear multi-variable regression method. The models are modified to calculate the wind factor based on the wind direction. The equation is given in *eqn* (39). An experiment was performed to validate this methodology.

The INNOVA gas monitoring system was used to measure the ACH for every minute. The room temperature was set to 75 F. The Syracuse airport weather data was obtained from NOAA. Figure 15 presents the wind speed and the wind direction data for every minute. Figure 16 shows for the outdoor temperature in a minute interval. Using this data, non-linear multi-variable regression was used to determine the model parameters for both AIM-2 and LBL models. The result is presented in Table 12.

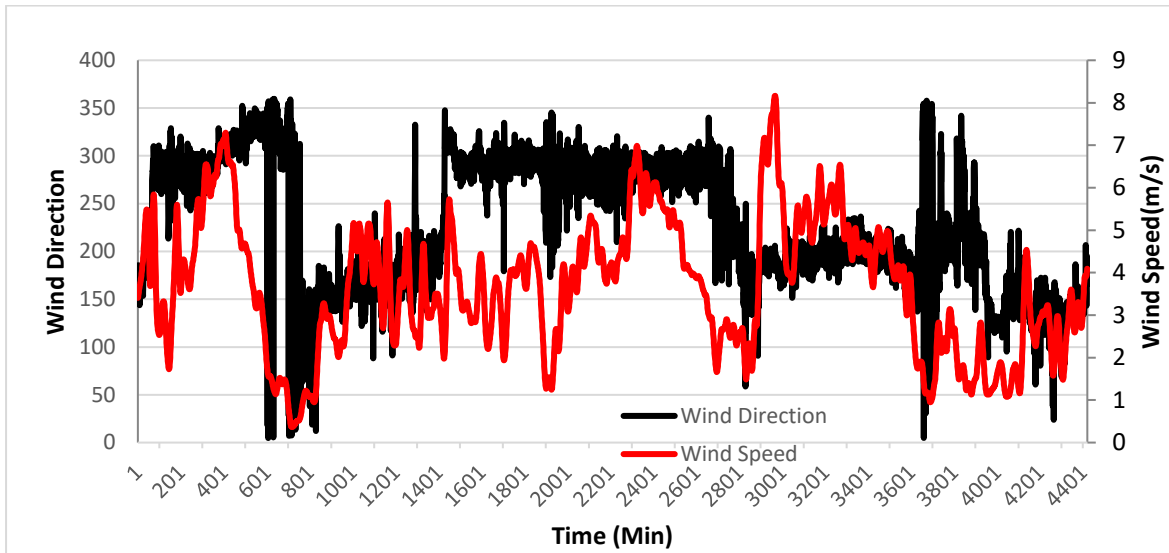

Figure 15: Wind speed and wind direction data

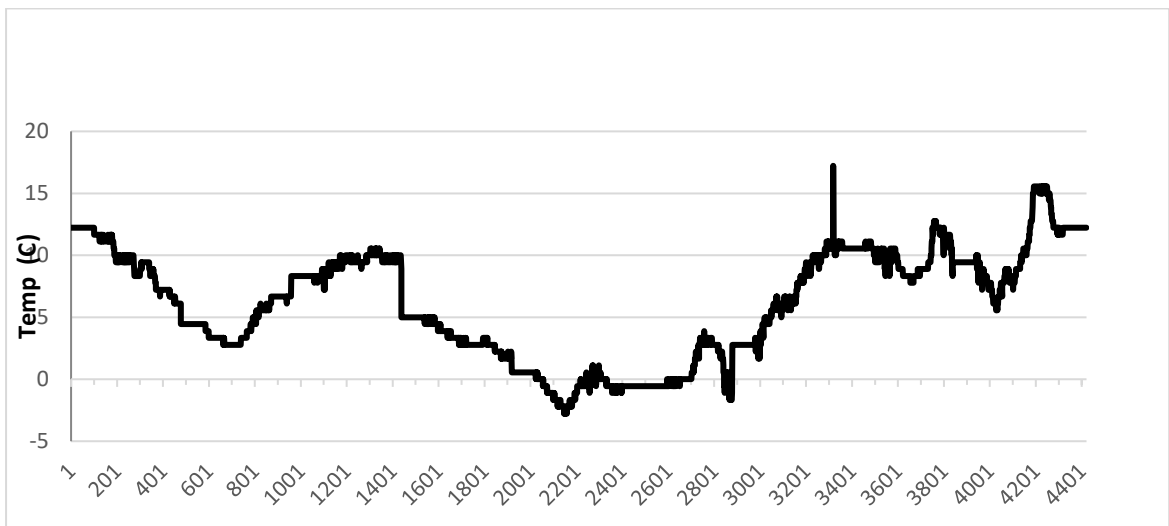

Figure 16: Outdoor air temperature data

Table 12: Model parameters obtained from regression test

	Wind Direction (deg)	AIM-2-Regression	LBL-Regression
Leakage Characteristics (C)		1.022	1.521
Leakage characteristics exponents(n)		0.677	0.704
Stack factor (fs)		0.489	0.177
Wind factor (fw)	0 and 30	0.469	0.410
	30 and 60	0.584	0.426
	60 and 90	0.576	0.426
	90 and 120	0.393	0.434
	120 and 150	0.402	0.306
	150 and 180	0.452	0.392
	180 and 210	0.434	0.318
	210 and 240	0.396	0.291
	240 and 270	0.509	0.359
	270 and 300	0.505	0.371
	300 and 330	0.499	0.408
	330 and 360	0.475	0.559

Figure 17 shows the wind factor as a function of the wind direction. The wind factor has a lower value for wind that comes from the east and southwest side. This is expected. As it was explained in the test site location in chapter 4, the southwest side and east side wind shield factor should be higher because of the hill and the vegetation, respectively. Including the local wind factor effect as a function of the wind direction increases the accuracy of the infiltration models.

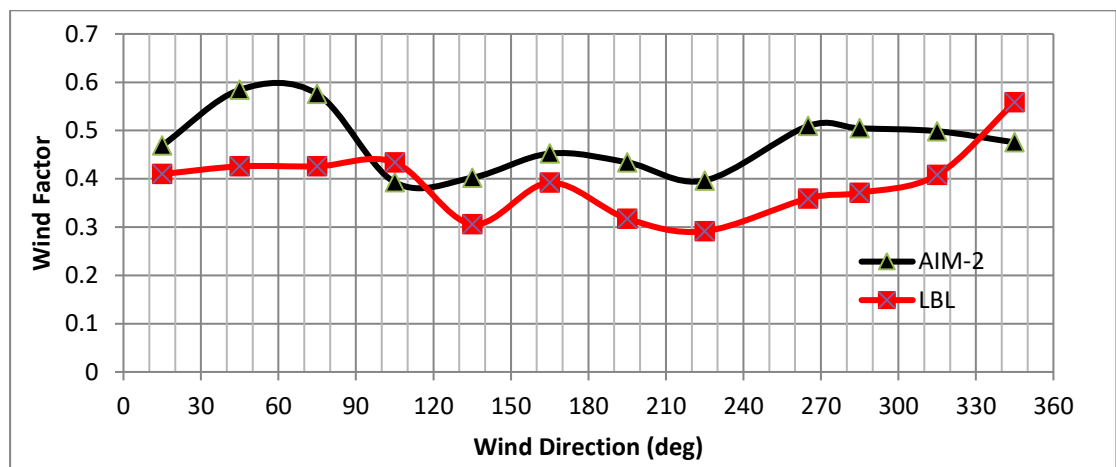

Figure 17: Air change obtained from constant concentration and decay method

Figure 18 shows the calculated ACH rate using the new methodology and the measurement ACH. The AIM2-Regression model fits measured ACH better than the LBL-Regression model. The LBL-Regression model tends to underestimate the higher ACH. The wind effect dominates the higher ACH. In the AIM-2-Regression model equation, the wind effect infiltration doubled the wind velocity. The application of the building leakage characteristics, C and n, in the AIM-2 infiltration equation is also different from LBL model as it was shown on Table 10.

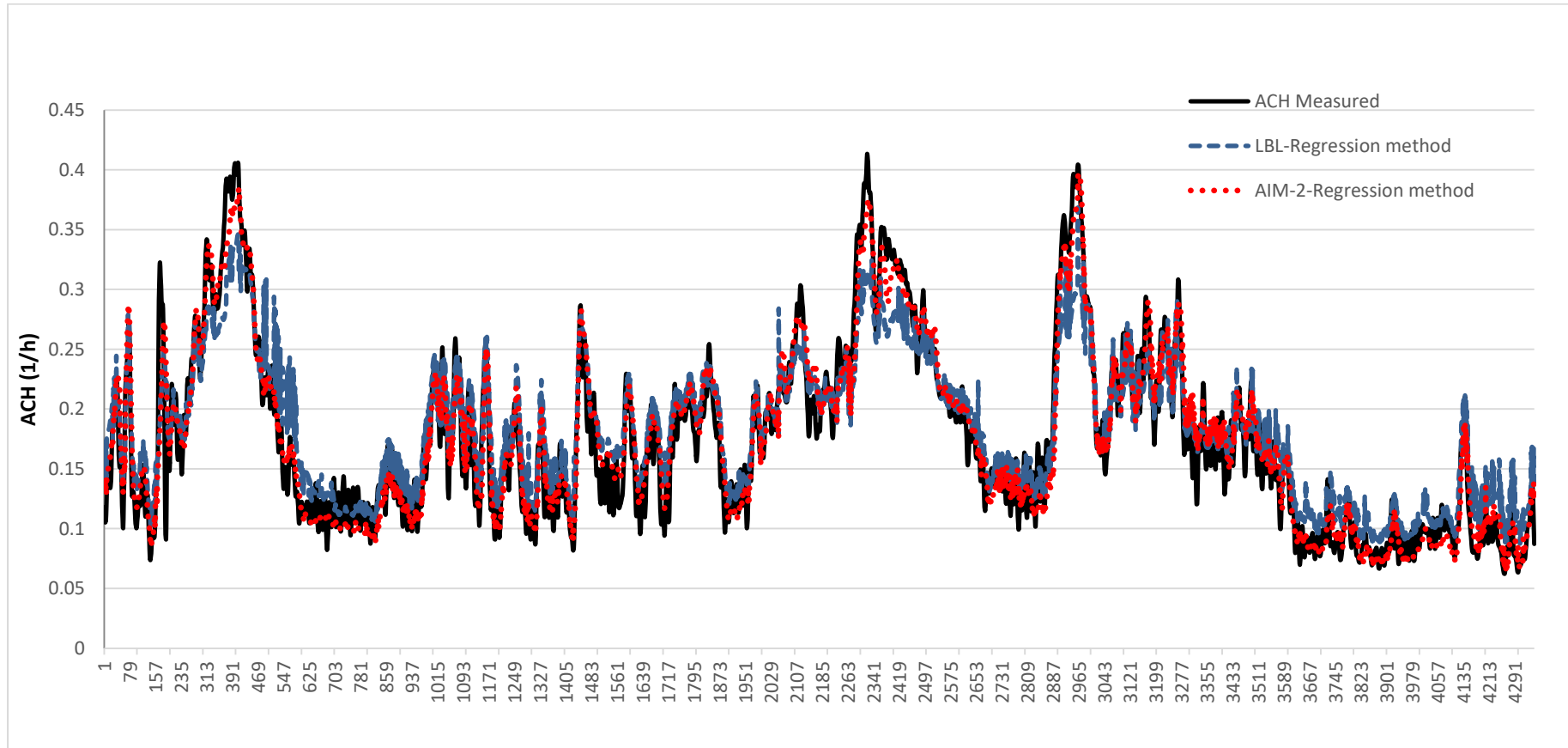

Figure 18: ACH from measurement, AIM-2-Regression, and LBL-Regression

Figure 19 and 20 present the comparison between the measured and predicted ACH for the AIM2-Regression and LBL-Regression models, respectively. The AIM2-Regression model captures the entire measured infiltration spectrum better than the LBL-Regression model. The LBL-Regression tends to underestimate the infiltration rate due to the wind effect and overestimate infiltration rate cause by the stack effect.

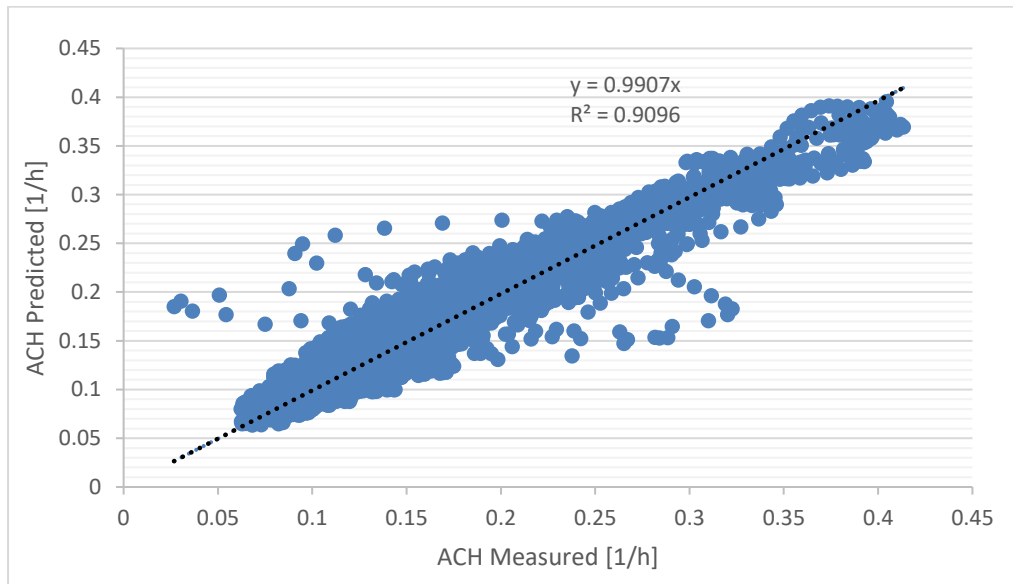

Figure 19: AIM-2-Regression result

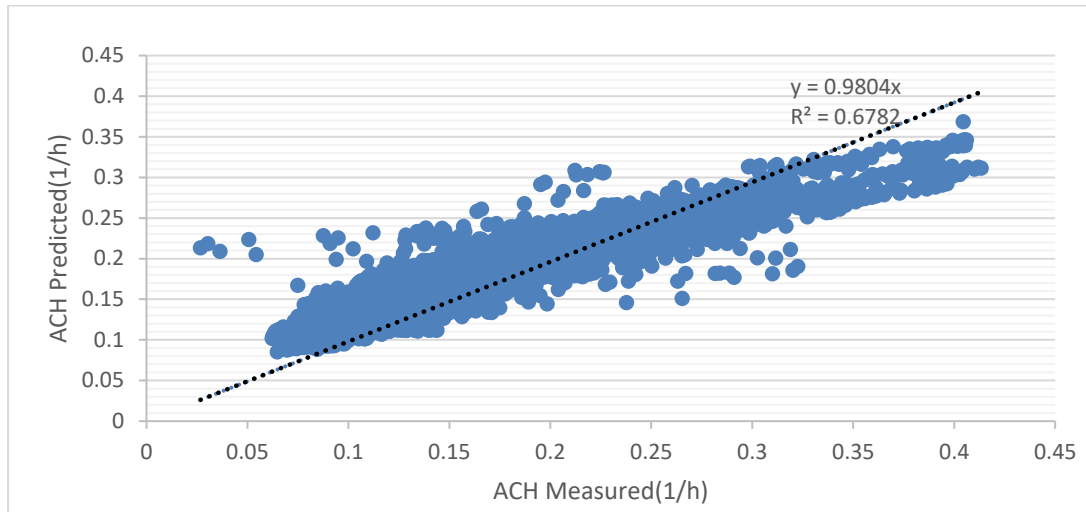

Figure 20: LBL-Regression result

The absolute percentage error was used to compare the AIM-2-Regression and LBL-Regression results. The error is calculated using the following equation:

$$|\mathbf{Error}\%| = \frac{|(ACH_{measured} - ACH_{predicted})|}{ACH_{measured}} * 100 \quad eqn (51)$$

Where $|\mathbf{Error}\%|$ =percentage error

$ACH_{measured}$ = Air change rate measured using tracer gas method

$ACH_{predicted}$ = Air change rate calculated using AIM-2 or LBL model

Table 13: Average percentage error for LBL-Regression and AIM-2-Regression model

	AIM-2-Regression	LBL-Regression
$ Error\% $	9.7%	15.6%
Standard deviation	9.2%	14.1%

Table 13 indicates that the AIM-2-Regression result has average an error of 9.7 % and standard deviation of 9.2%. The LBL-Regression result, however, indicates an average error of 15.6% and a standard deviation of 14.1%

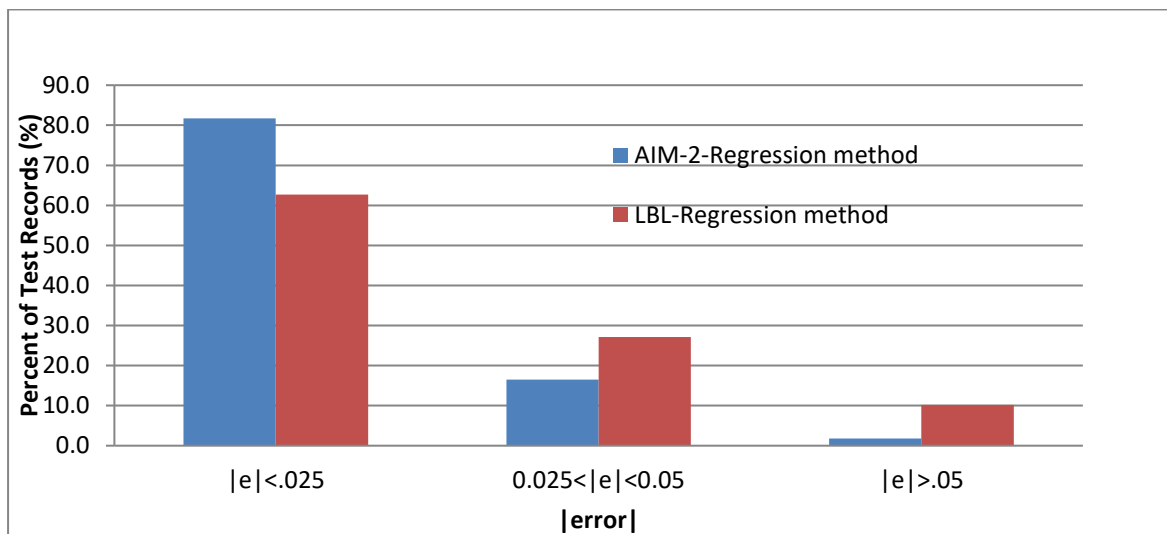

Figure 21: The error distribution of AIM-2 Regression and LBL-Regression

Figure 21 shows the absolute error distribution for the AIM-2-Regression and LBL-Regression result. The AIM-2-Regression prediction has 82% of the test records with accuracy of ± 0.025 1/h and 98% of the data has an accuracy of ± 0.05 1/h. For LBL,

63% of the data measured has an accuracy of ± 0.025 1/h and 90% measured data has accuracy of ± 0.05 1/h.

From the result above, it can be concluded that the AIM2-Regression model predicts the air change rate better than the LBL-Regression model.

Figure 22 presents the infiltration rate due to the wind effect from the AIM2-Regression model and LBL-Regression model. The wind effect dominates the ACH when the wind speed is higher. At a higher wind speed, the AIM2-Regression model predicts a higher ACH than the LBL-Regression model.

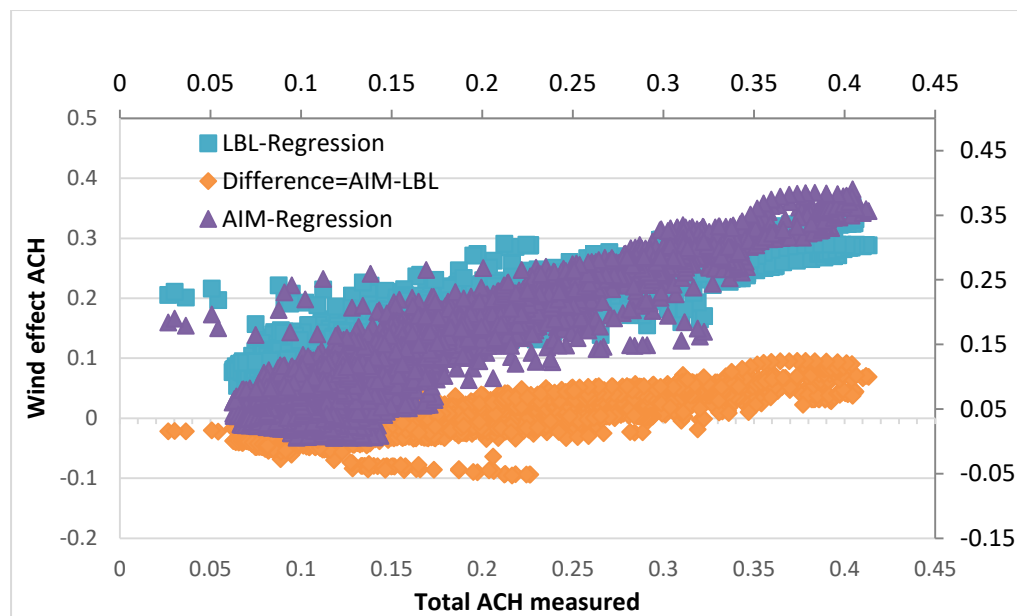

Figure 22: ACH due to wind effect

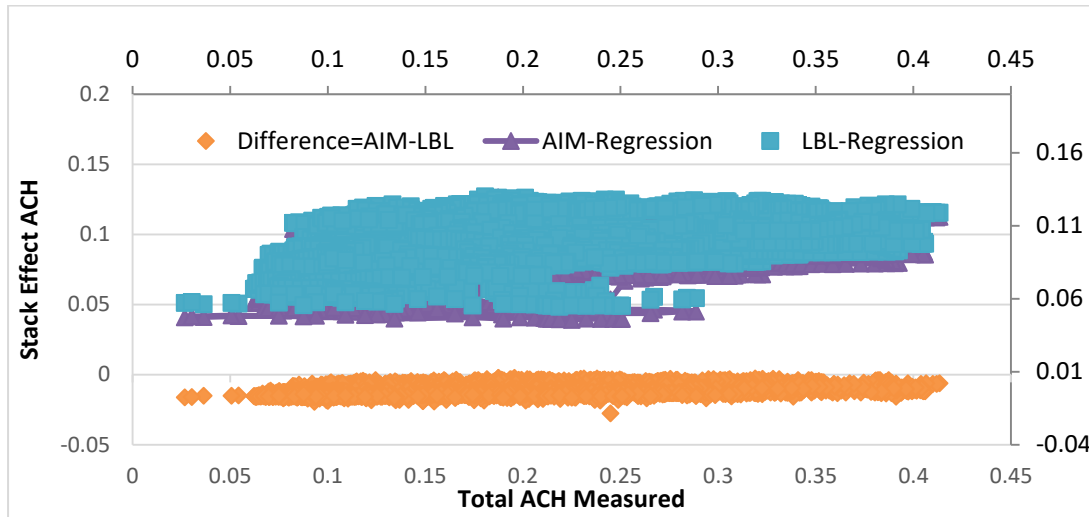

Figure 23: ACH due to stack effect

Figure 23 presents the stack effect ACH calculated from AIM-2-Regression model and LBL Regression model. The LBL-Regression model predicts the stack effect ACH slight higher than the AIM-2 regression model. Their differences are more or less consistent through the range.

5.5.1.1 Comparison of AIM-2-Regression and AIM-2 Standard methods

The AIM-2 modeled infiltration rate was calculated by using the standard method explained in chapter 2. The building leakage characteristics were obtained from the blower door test. Understanding the leakage distribution is important to determine the wind factor and the stack factor. These factors are dependent on X and R, which are defined as a function of total building leakage characteristic, ceiling leakage characteristic, and floor leakage characteristics given in Equation 26 and 27, respectively. BEST lab has no sub-basement or crawl space. It has a concrete floor. The leakage through the floor is assumed to be zero. In this case, the X and R values are equal. X and R values are the ratio of the ceiling leakage to overall leakage. It is

difficult to determine this ratio. Three different ratios (0.37, 0.5' and 0.6) were taken and analyzed.

Figure 24 presents the predicted ACH using the new method (AIM-2-Regression) and three standard AIM-2 models against the measured ACH. The new proposed method follows closely the measured ACH trend. The ACH calculated when $X=R=0.6$ predicts the ACH better when the ACH less than 0.2. A lower ACH is usually dominated by the stack effect. The ACH calculated using $X=R=0.37$ predicts the ACH better when the ACH is greater than 0.2, which is dominated by wind effect.

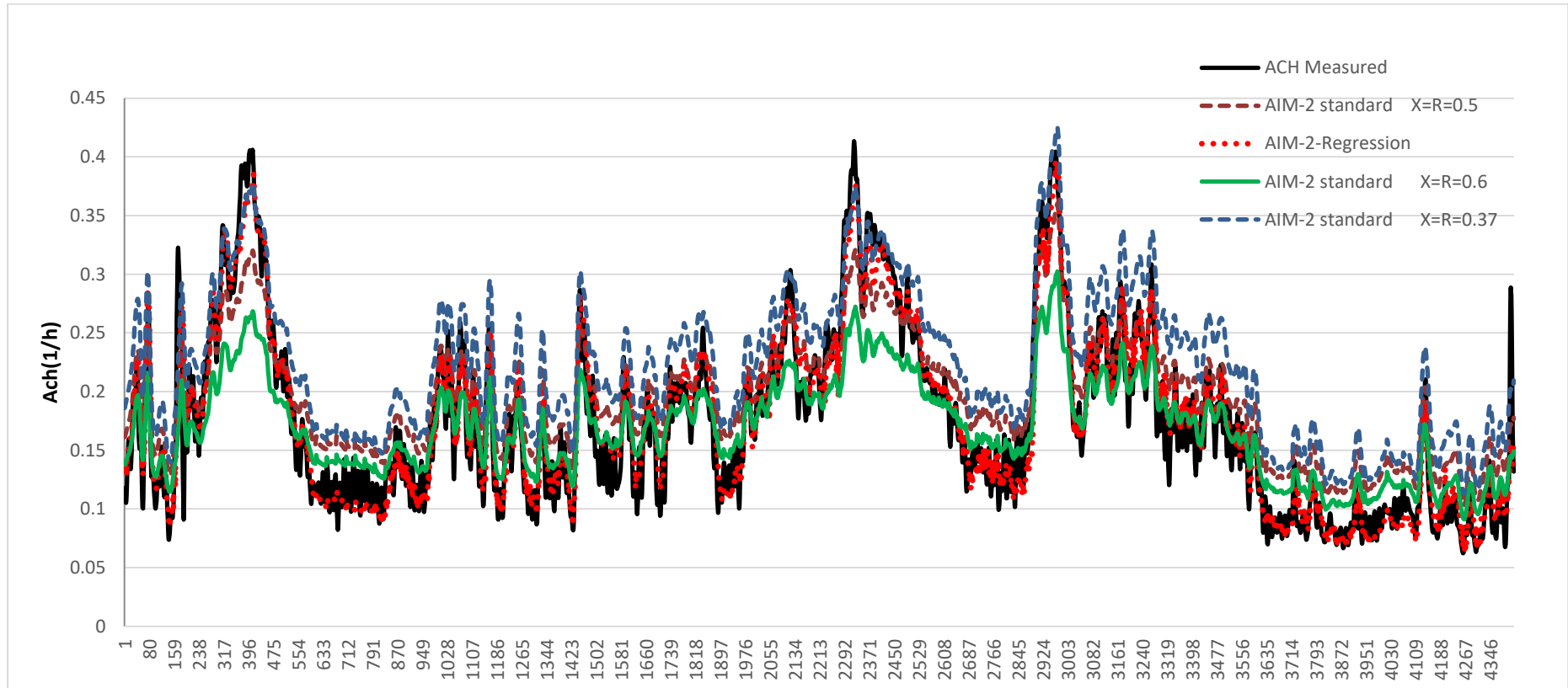

Figure 24: Comparison between measured and predicted ACH

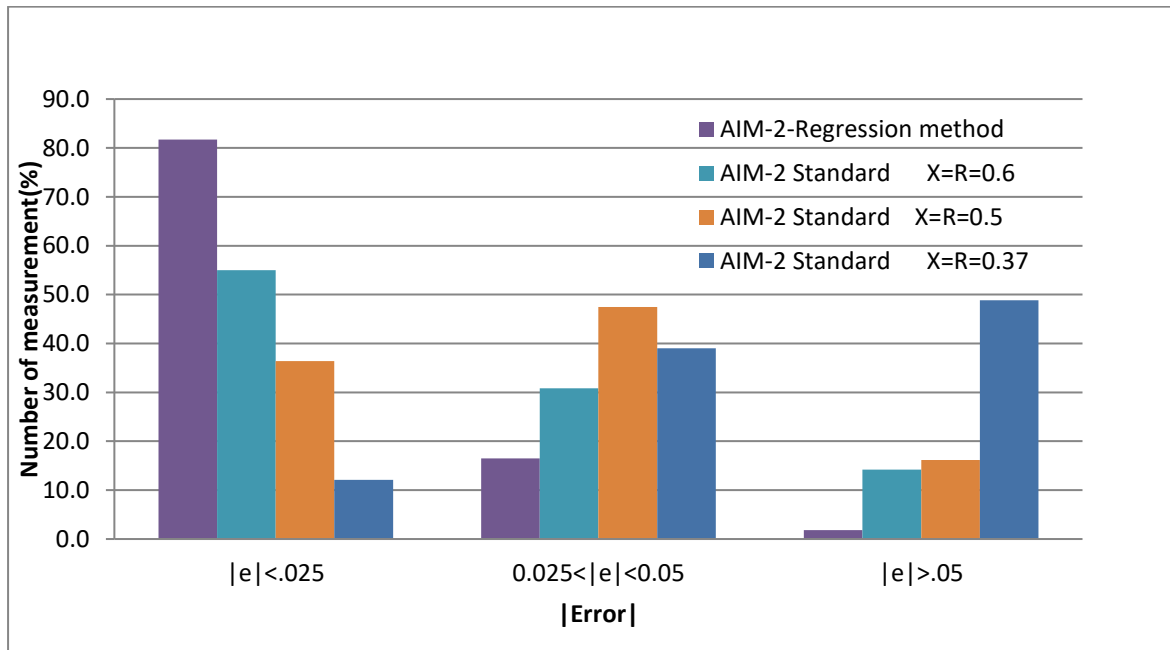

Figure 25: AIM-2 model error distribution

Figure 25 shows the absolute error distribution of the AIM-2 models. The new method shows a better accuracy. Almost 98% of the recorded data has an accuracy of ± 0.05 ACH. The standard AIM-2 with $X=R=0.37$ tends to have the lowest accuracy.

The standard AIM-2 model when $X=R=0.6$ appeared to give a better ACH prediction than the other standard AIM-2 model. But this is not true. The reason is that much of the data recorded is below 0.2, ACH which indicates that the infiltration is dominated by stack effect. The impact of the leakage distribution estimation on the standard AIM-2 model is better explained in the Figure 26 below. The AIM-2 model with $X= R=0.6$ gives a better result for ACH less than 0.25. For ACH between 0.25 and 0.4, it is better predicted by $X=R=0.5$. For infiltration dominated by the wind effect, ACH greater than

0.35, it is better estimated when $X=R=0.37$. A key advantages of the AIM-2-Regression is that it does not need to quantify the air leakage distribution ratios X and R .

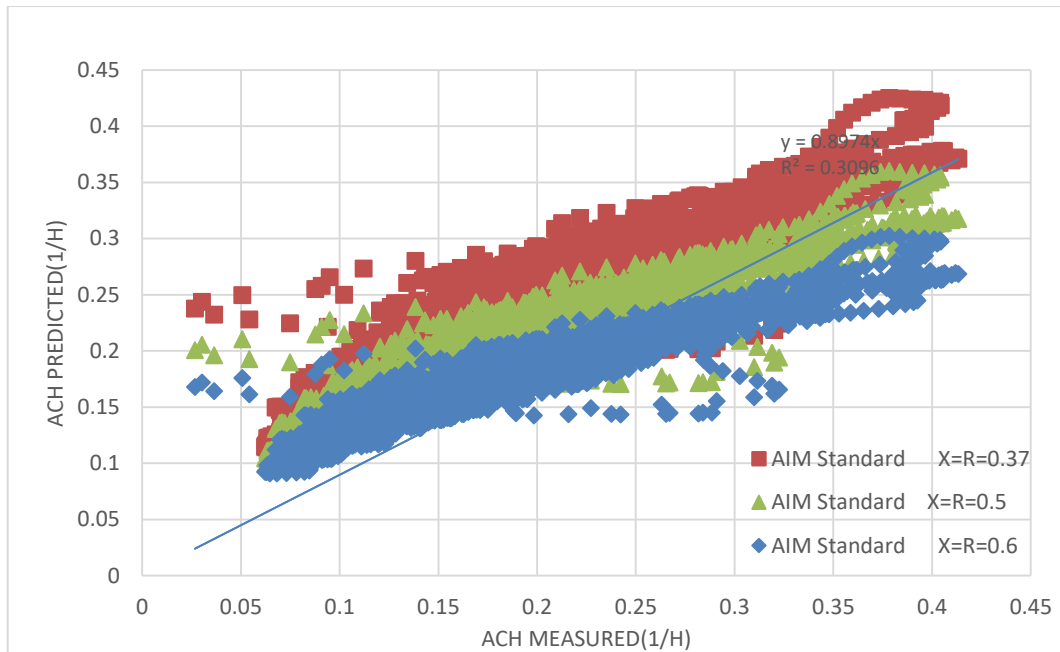

Figure 26: ACH measured and ACH predicted using AIM-2 model

5.6 Compare the models with other studies

Different studies were made to validate the infiltration models. (Franciso and Palmiter, 1996) studied in ten single-family homes. (Wang et al., 2009) evaluated the AIM-2 model. The results are presented in Table 7 below.

Table 14 : Comparison of AIM-2 regression with AIM 2 model done in other studies

	AIM-2-Regression (BEST Lab)	Standard AIM-2 model prediction (BEST Lab)			Franciso and Palmiter, 1996		Wang et al., 2009
		X=R=0.6	X=R=0.5	X=R=0.37	X=R=0.5	X=0 & R=0.5	X=0 & R=0.5
Leakage Distribution	Not Applicable						
Error %	9.7	17.3	24	35	16.2	46	19
Standard Deviation (%)	9.2	12.7	18.6	22.6			16

Table 14 shows the percentage error of AIM-2 model for BEST laboratory and work done in previous studies. We can see that the AIM-2-Regression is the only method able to predict the ACH with an average absolute value error less than 10 %.

5.7 The impact of regression data size and data quality

The AIM-2-Regression model predicts the ACH better than the standard AIM-2 model. In this section, the impact of the data size and the data range was studied. The total number of data collected was 4400. The data was split to two parts. The first part of the data is used to determine the model parameters and the rest of the data is used to predict the ACH. Six regression analyses were done. Table 15 shows the data size used for each regression to determine the model parameter.

Table 15 : Data size used in the regression

	Total data size	Data size used for regression analysis	Data size used to predict ACH
Regression 1	4400	300	4100
Regression 2	4400	450	3950
Regression 3	4400	600	3800
Regression 4	4400	750	3650
Regression 5	4400	900	3500
Regression 6	4400	1050	3350

The ACH percentage error was calculated using *eqn (51)* for the six regression results. Figure 27 shows the impact of the data size used to determine the AIM-2-Regression model parameter on the average error. The error is 18% for the data size of 300. It drops to 10% when the data size is increased to 450. Not a huge impact was observed by increasing the data size by more than 450.

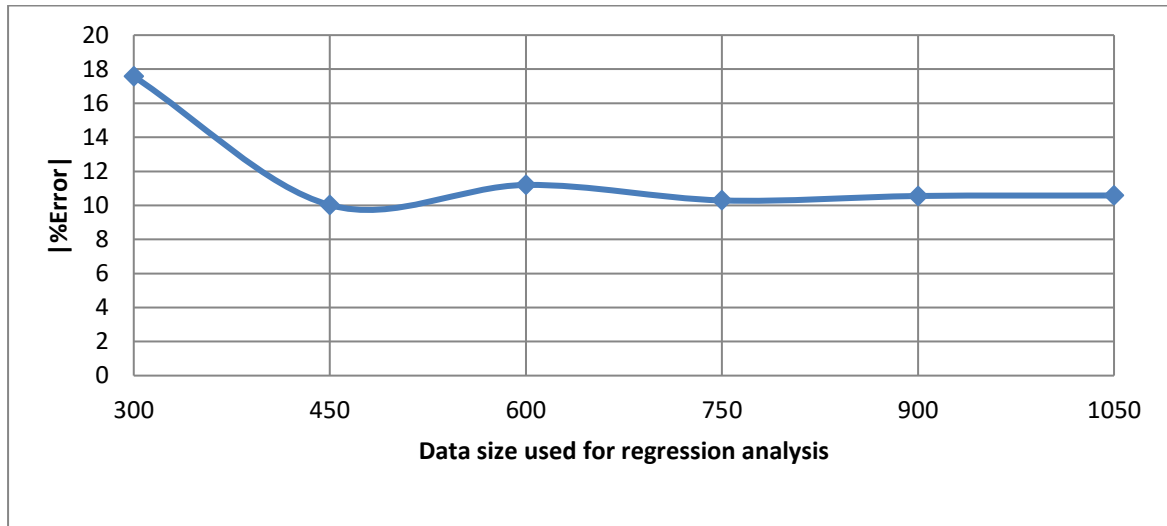

Figure 27: Impact of the data size in AIM-2-Regression model

The above result did not indicate the impact of the data quality. In the new AIM-2-Regression model the wind factor is dependent on the wind direction. Figure 28 shows the data size in the wind direction range. One fourth of the collected data has a wind direction between 270 and 300 degree.

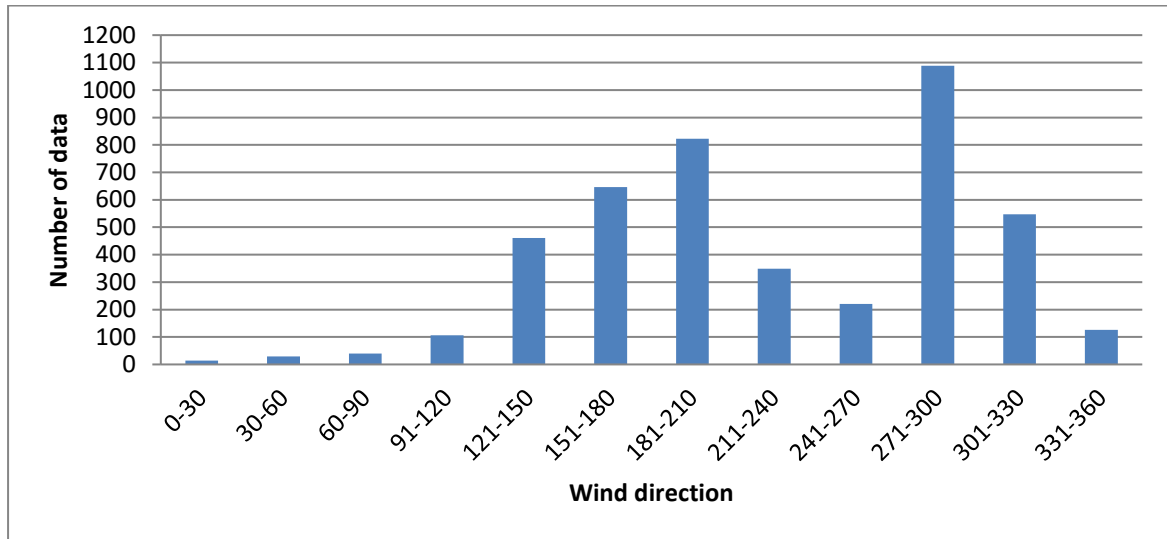

Figure 28: Data distribution based on wind direction

To understand the impact of the data quality, the data was filtered for wind direction between 270 and 300. AIM-2-Regression model used a single wind factor (f_w) for the wind direction range. Figure 29 presented the wind speed and the wind direction of the filtered data. This data set contained wind speed range from 1 m/s to 9 m/s. The data size is 1100.

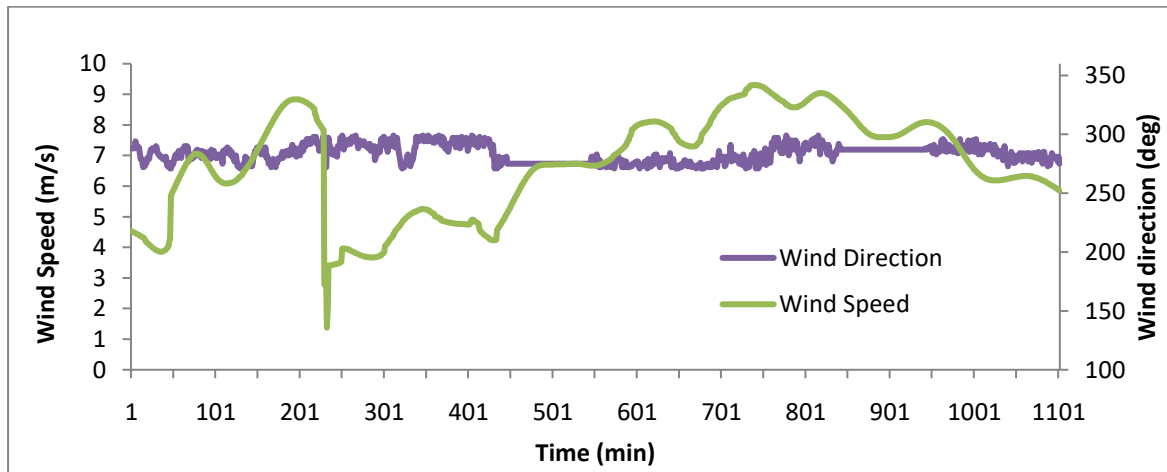

Figure 29: Wind speed data for wind direction between 270 and 300 degree

Six regressions were estimated to determine the AIM-2-Regression model parameter using different data size. Table 16 presents the data size used to do the regression test. The rest of the data was used to predict the ACH.

Table 16 : Data size used in the regression for the filtered data

	Total data	Data size used for regression	Data size used ACH prediction
Regression 1	1160	50	1190
Regression 2	1160	100	3950
Regression 3	1160	200	3800
Regression 4	1160	250	3650
Regression 5	1160	300	3500
Regression 6	1160	350	3350

The average ACH percentage error was calculated using *eqn (51)* . Figure 30 presents the ACH percentage error as a function of the data size used to determine the model parameter. The error dropped from 20% to 11% when the data size used for regression increased from the first 50 to first 100. The first 50 data points contained wind speed range from 4 to 5 m/s. However, the first hundred data points contained a wind speed range from 4 to 7 m/s. If we looked the first 250 data points, the data cover the wind speed range from 1 to 9m/s and the error reduces to 8%. This shows that the accuracy of this model is highly dependent on wind speed spectrum in each wind direction. In this dissertation, the wind direction range was 30 degree as shown in *eqn (51)*.

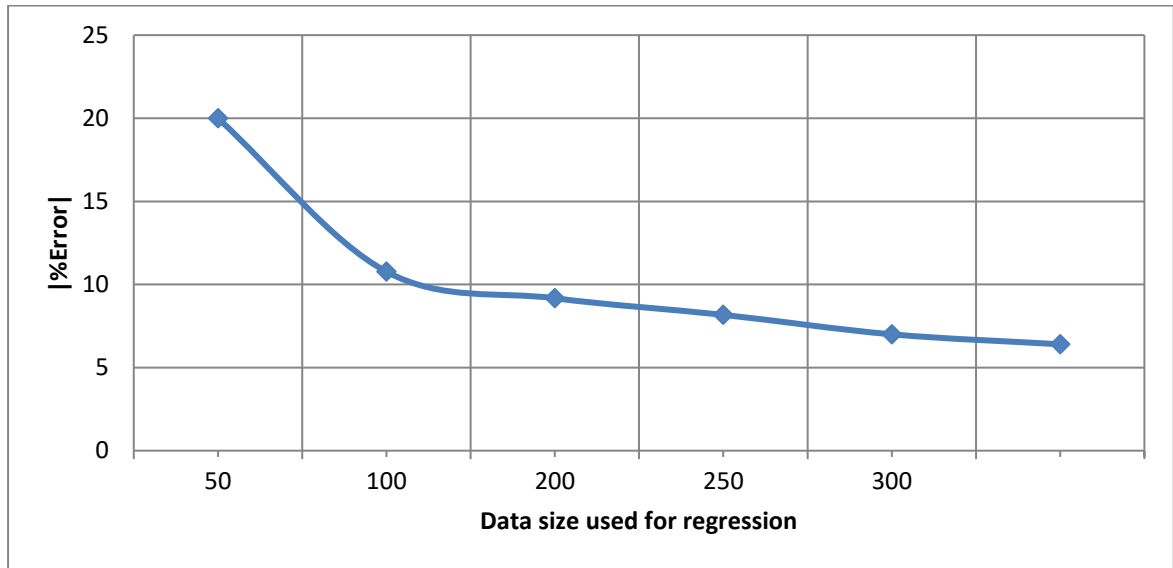

Figure 30: Impact of the data size quality on AIM-2-Regression model

6 APPLICATION

6.1 Application

A simple low cost monitoring and measuring device was constructed to apply the new methodology developed in chapter three. The device should be able to perform the tracer gas decay method and measure the room temperature. The weather data is collected from the nearby weather station (e.g. airport weather data) . The user should be able to control when to perform the tracer gas test or to monitor the indoor air quality. The device is composed of a temperature sensor, humidity sensor, carbon dioxide sensor, a solenoid valve, and Arduino Yun micro controller. The Arduino microcontroller is the integral part of this device. This microcontroller is selected for the following reasons:

1. It is cheap. It costs from \$30 to \$70 based on additional futures.
2. It can be connected to Wi-Fi or internet.
3. It stores data on a SD card.
4. It is easily programmable and uses an open source program.

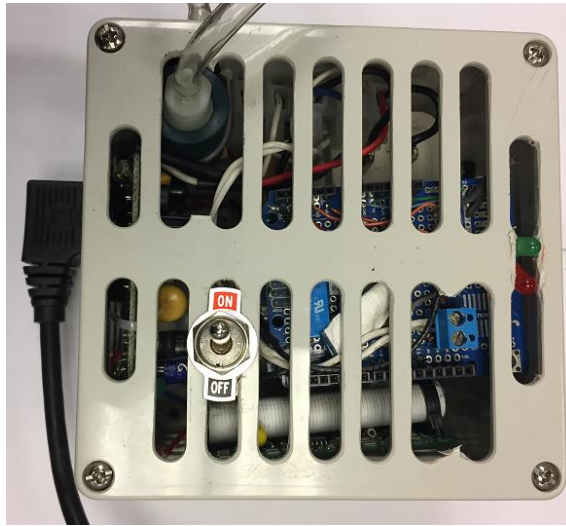

Figure 31: IAQ monitoring and measuring device

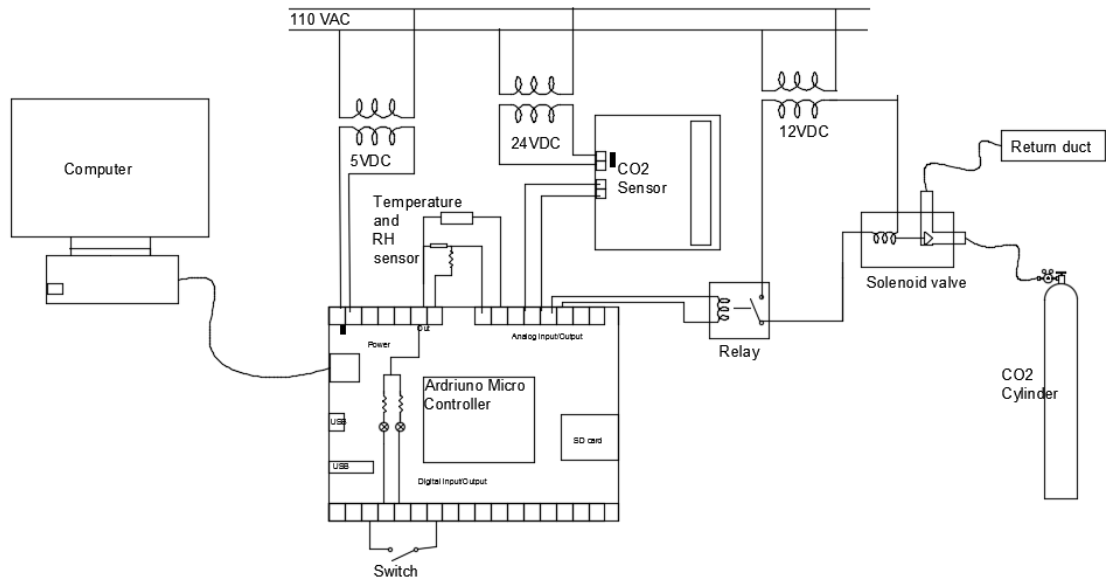

Figure 32: Device schematic diagram

Figures 31 and 32 show the picture and the schematic diagram of the IAQ monitoring and measuring device. The device uses a 110 ACV power supply. This power is converted to 5 VDC, 24 VDC, and 12 VDC to power the microcontroller, CO_2 sensor and

solenoid valve, respectively. The microprocessor power output is used to power the temperature and humidity sensors. The sensors output signals are connected to the microprocessor analog inputs and the data is stored in the SD drive. This data can be downloaded through direct connection to the computer or through a Wi-Fi connection.

The device has two settings: calibration and monitoring. The toggle switch is used to select these options. When the switch is turned on, the device is set to run the tracer gas decay method and to measure the room temperature. The red LED light turns on to indicate that the tracer gas might be injected. Based on the tracer gas concentration the microprocessor turns the solenoid valve on and off using solid state relay. The solenoid valve gas input is connected to the tracer gas cylinder and the valve output is connected to the return duct in the air circulation system.

Calibration is important to determine the infiltration model parameter of the house.

To do the calibration, the following items should be satisfied:

1. CO₂ sources (occupants and pet) should not be in the house.
2. Windows and entrance doors should be closed.
3. Doors between rooms should be left open.
4. The circulation fan must be set to run continuously.
5. The device tracer gas input should be connected to the CO₂ cylinder and the gas output should be attached to the return duct.

This device injects the tracer gas into the room until it reaches 1200 ppm. The CO₂ sensor is capable of measuring up to 1200 ppm. The valve turns off and tracer gas

injection stops. The tracer gas concentration is measured for every minute and stored into the SD card. The valve turns on when the tracer gas concentration reaches 550 ppm. This process repeats until the switch is turned off.

When the switch turns off, the device is set to monitoring mode. The solenoid valve is closed and CO_2 is not injected into the test space. The green LED light turns on. The device measures the CO_2 level, the room temperature, and the room humidity for every minute.

This device was tested in the BEST laboratory. The device was set to calibration mode to determine the AIM-2 model parameter using tracer gas decay method. The data was collected for every minute. The test was run for two days. Figure 33 shows the tracer gas, CO_2 , concentration in the decay process. Tracer gas was injected four times during the test period. The injection time interval between the second and the third injection as well as the third and fourth injection were short. This shows that the infiltration rate was higher between these periods.

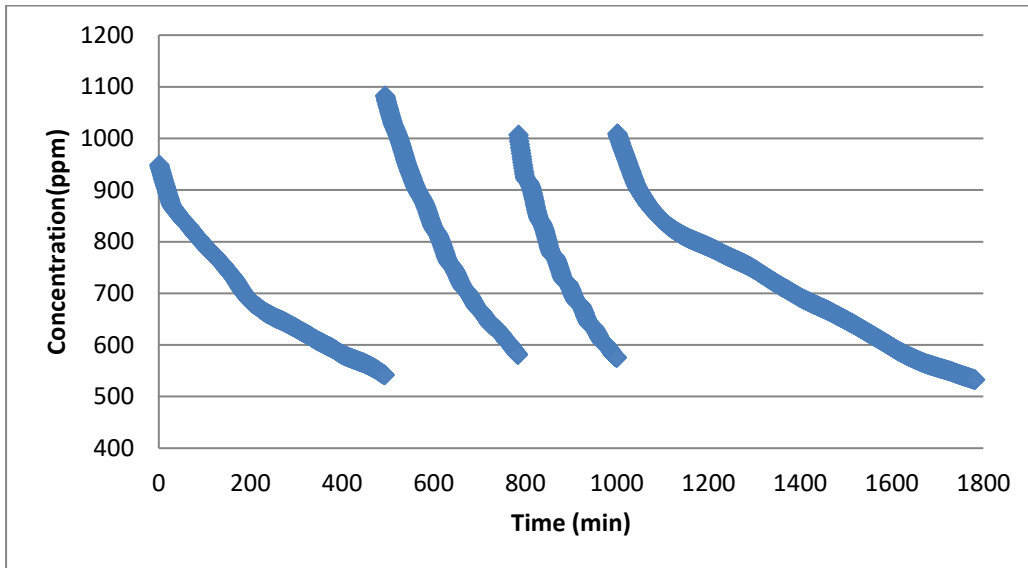

Figure 33: CO₂ concentration measurement

The Syracuse airport weather data was obtained from NOAA. Figure 34 shows the wind direction of the collected data. Figure 35 presents the data size as a function of wind direction. The data shows that the wind was blowing in northeast, north, east, and northwest directions.

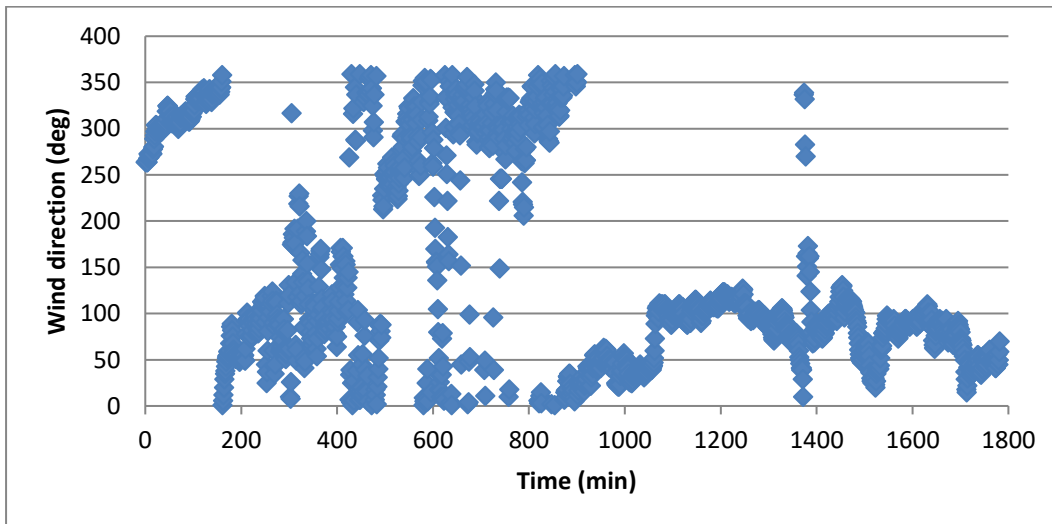

Figure 34: Wind direction

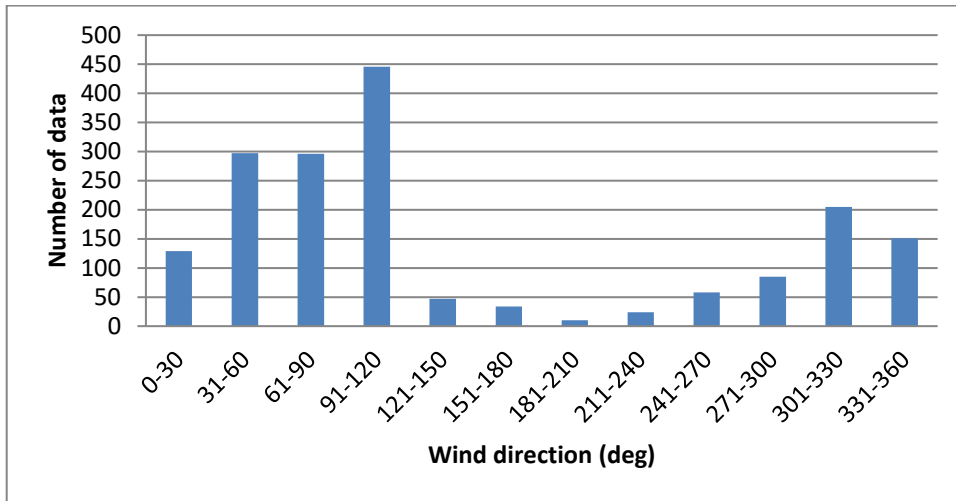

Figure 35: Data distribution in a wind direction

Figure 36 presents the wind speed. The wind speed varied from 0.5 m/s to 8 m/s. Figure 37 shows the indoor and the outdoor air temperature. The indoor air temperature data was collected using the new device. The outdoor temperature data was obtained from NOAA.

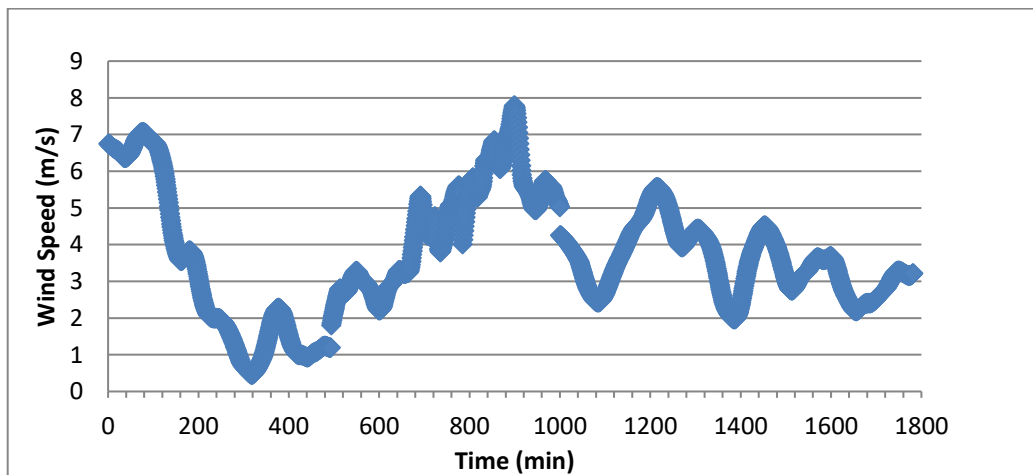

Figure 36: Wind speed

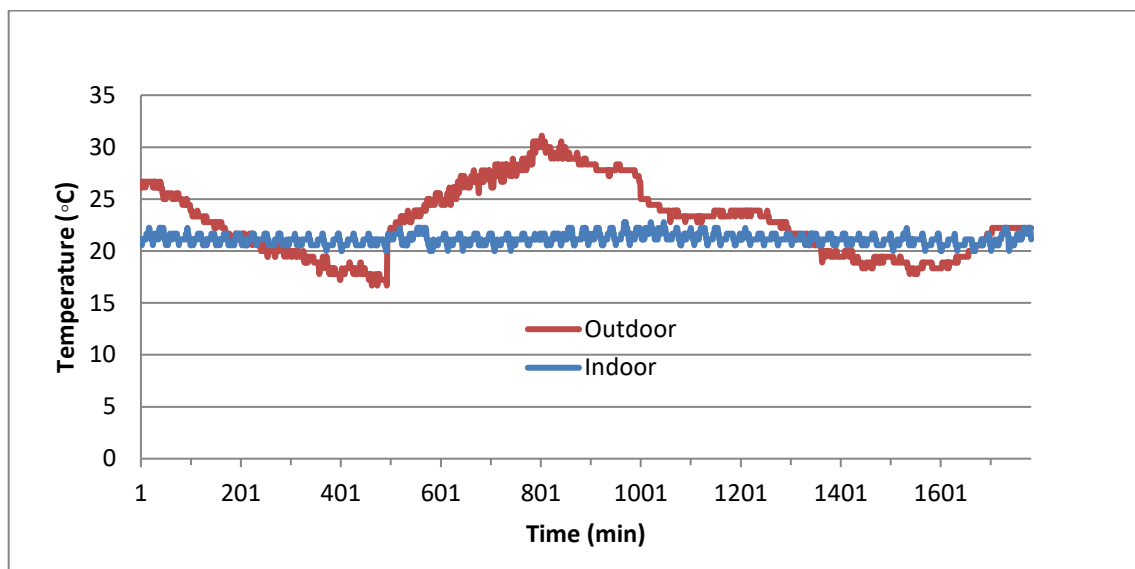

Figure 37: Indoor and outdoor temperature

Non-linear multi-variable regression analysis was used to determine the AIM-2 model parameter. The results are presented in table 17. The wind factor (f_w) values for wind direction between 60 and 150 degree are small. This is expected because trees shield the east side of the building. The wind factor for wind direction between 120 and 330 might not be valid because sufficient data was not collected.

Table 17: Model parameters obtained from regression test

	Wind Direction (deg)	AIM-2-Regression
Leakage Characteristics (C)		1.230
Leakage characteristics exponents(n)		0.520
Stack factor (fs)		0.561
Wind factor (fw)	0 and 30	0.432
	30 and 60	0.392
	60 and 90	0.287
	90 and 120	0.181
	120 and 150	0.203
	150 and 180	0.558
	180 and 210	0.706
	210 and 240	0.831
	240 and 270	0.609
	270 and 300	0.425
	300 and 330	0.412
330 and 360	0.355	

Figure 38 presents the measured ACH from the device and the calculated ACH using parameters from Table 12 and Table 17. The measured value and the AIM-2-Regression value using the new device data follow the same trend. The AIM-2-Regression result from Table 12 parameters is higher. The reason is that the wind factor for wind direction between 0 and 120, and between 330 and 360 degree are inaccurate because insufficient data was not collected to get a valid regression result.

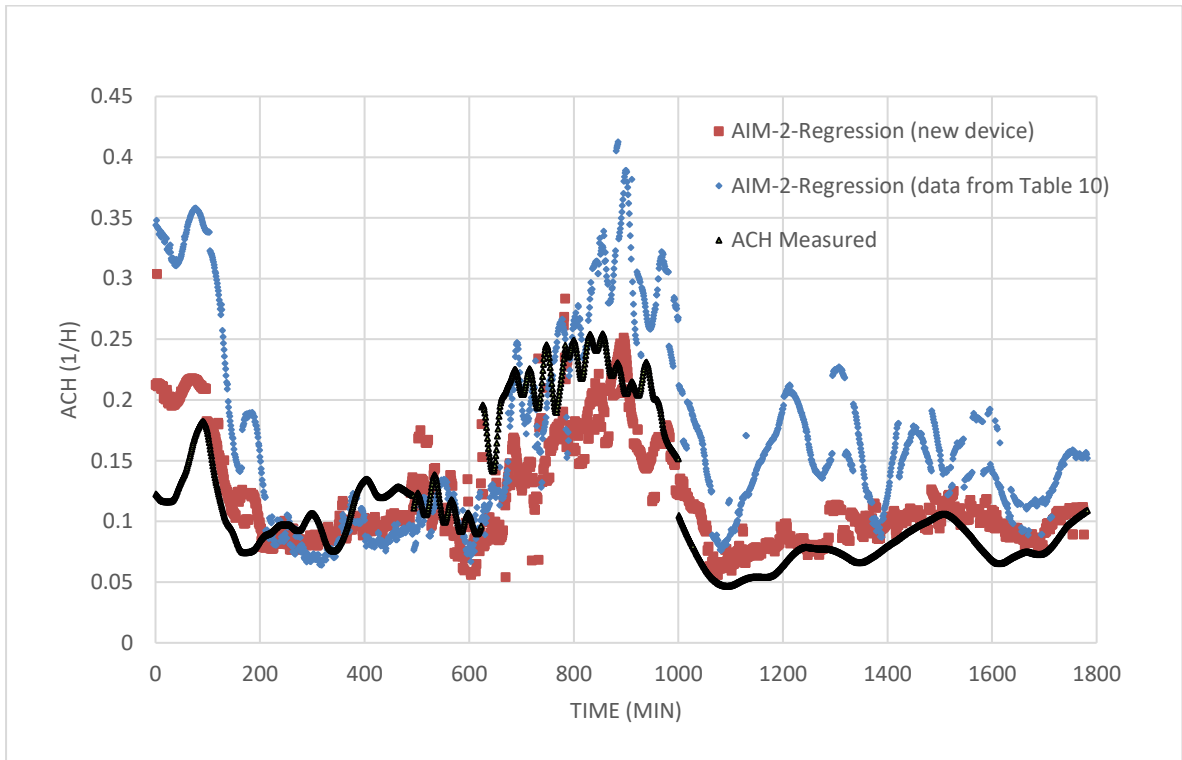

Figure 38: Measured and predicted ACH

7 SUMMARY AND CONCLUSIONS

The most advanced models, AIM-2 and LBL, rely on determining the building leakage characteristic, the shield effect and the leakage distribution ratio. The standard way of measuring building leakage characteristics is building pressurization test. Other parameters are obtained from qualitative analysis and tabulated data. This technique requires skilled labor and expensive equipment. Shield effect and leakage distribution are difficult to determine. In this dissertation, a methodology is developed to combine the tracer gas method and infiltration models to predict ACH in the occupied house with better accuracy and less cost. The decay tracer gas is used to calibrate building leakage characteristics and the surrounding shield effect. This method does not require skilled person or heavy equipment. A simple device was developed to implement the method in low income naturally ventilated houses.

The method, its' assumptions, and its' limitations were validated. The findings are summarized as followed:

- Running the circulation fan in naturally ventilated house creates a well-mix condition.
- Decay tracer gas method can be used to estimate near-real time ACH, if the decay process is captured in a minute interval.
- The standard AIM-2 or LBL accuracy is heavily dependent on air leakage distribution factors (X and R). These factors are difficult to predict.

- Weather data, CO_2 monitoring and decay method can be used to predict the building leakage characteristics, wind factor, and stack factor.
- AIM-2-Regression method predicts ACH better than LBL-Regression
- The accuracy of the new methodology is dependent on the number of records and the data quality obtained from regression analysis. The data quality is mainly focused on a wide wind speed spectrum in the wind direction range.
- The advancement in sensor technology and microprocessor make tracer gas decay method easier and cheaper to measure building leakage characteristics than pressurization test.

8 FUTURE WORK

This work can be extended in the following areas:

1. The new methodology is applicable to measure ACH when the house doors and windows are closed. The method could be extended to include the impact of the opened doors and windows. The impact of human interaction with the building can also be explored.
2. The requirement of CO_2 cylinder to calibrate the building might not be convenient for the user. The CO_2 concentration in the house when the occupants leave might be used to calibrate the model parameter. The concentration should be high enough from the outdoor CO_2 concentration.
3. The new device can be extended to measure the occupants' number based on the Wi-Fi signal received from the mobile phone and/or CO_2 level. This will help to estimate the ACH required based on the occupant.

9 APPENDIX

Appendix A: Pressurization test Procedure

The purpose of this test is to determine the building leakage characteristics. The fan blows air to the room to keep the set pressure difference across the building enclosure to set point. The air flow is measured using IRIS damper. The pressure difference across the IRIS damper is measured and converted to flow rate. The Pressurization test procedure is stated below:

1. Turn on the fan.
2. Set up the PID fan controller to keep the pressure difference between the indoor and outdoor at 10 Pa.
3. Wait till the pressure difference measurement stabilized.
4. Measure and log the pressure difference across the IRIS damper. This pressure difference is convert to the flow rate
5. Increase the set point by 10 Pa
6. Follow step 3 and 5

Appendix B: Tracer gas decay test Procedure

Tracer gas decay method is used to measure the air change rate in the control volume. Tracer gas is injected into the test space until it reaches a set level. The tracer gas concentration is measure every minute. The air change rate is calculated from this data. To do this experiment we have to a well-mix condition in the test space. The procedure of decay tracer gas method is stated as followed:

1. Turn on the circulation fan to create a well mix-condition.
2. The CO₂ cylinder is directly connected to the air circulation system before or after the circulation fan.
3. Set the INNOVA tracer gas monitor to measure and log the concentration level every minute.
4. The CO₂ cylinder is directly connected to the air circulation system before or after the circulation fan.
5. Inject CO₂ gas by opening the cylinder valve until the concentration reaches 1300 ppm
6. Close the cylinder valve.
7. Stop the experiment when the concentration reaches the background tracer gas level

Appendix C: Tracer gas constant concentration test Procedure

The INNOVA tracer gas monitoring system is used to perform this test. The equipment measure and inject the tracer gas to keep the room concentration at a constant level. The tracer gas injection is directly proportional to the infiltration rate. This test procedure is:

1. Turn on the circulation fan to create well mix condition.
2. Connect the tracer gas pressurized cylinder to the Multipoint sampler
3. Run auto-calibration.
4. Set the INNOVA Tracer gas monitor PID control to maintain SF₆ Concentration to 8 mg/m³. The device is set to control the concentration level of the second floor.
5. Set the INNOVA device to monitor the tracer gas concentration level
6. Run the experiment

10 REFERENCES

- ASTM D6245-12, 2012. Guide for Using Indoor Carbon Dioxide Concentrations to Evaluate Indoor Air Quality and Ventilation. ASTM International.
- ASTM E741-11, 2011. Test Method for Determining Air Change in a Single Zone by Means of a Tracer Gas Dilution. ASTM International.
- ASTM E779-10, 2010. Test Method for Determining Air Leakage Rate by Fan Pressurization. ASTM International.
- Awbi, H.B., 2003. Ventilation of buildings, 2nd ed. ed. Spon Press, London ; New York.
- Borchiellini, R., 1997. Technical Note: Function Estimation of Ventilation Rates from Tracer Gas Measurement. *Build. Environ.* 32, 267–185.
- Card, W.H., Sallman, A., Grahm, R., Drucker, 1980. Infrasonic Measurement of Building Air Leakage: A Progress Report. *Am. Soc. Test. Materials ASTM STP 719*, 73–79.
- Carey, P., Etheridge, D., 2001. Leakage measurements using unsteady techniques with particular reference to large buildings. *Build. Serv. Eng. Res. Technol.* 22, 69–82.
- Chan, M., Estève, D., Escriba, C., Campo, E., 2008. A review of smart homes—Present state and future challenges. *Comput. Methods Programs Biomed.* 91, 55–81.
- Dewsbury, J., 1996a. AC pressurisation: Analysis by non-linear optimisation. *Build. Serv. Eng. Res. Technol.* 17, 65–71.
- Dewsbury, J., 1996b. AC Pressurization: Fourier Analysis and the Effect of Compressibility. *Build. Serv. Eng. Res. Technol.* 17(2), 73–79.
- Francisco, P.W., Palmiter, L., n.d. Infiltration and Ventilation Measurements on Three Electrically-Heated Multifamily Buildings. Ecotope Inc.
- Francisco, P.W., Palmiter, L., 1996. Modeled and Measured Infiltration in Ten Single-Family Homes. American Council for Energy and Economy, Washington DC, USA.
- Guo, L., Lewis, J.O., 2007. Carbon dioxide concentration and its application on estimating the air change rate in typical Irish houses. *Int. J. Vent.* 6, 235–245.
- Hawthorne, A.R., Gammage, R.B., Dudley, C.S., 1986. An indoor air quality study of 40 east Tennessee homes. *Environ. Int.* 12, 221–239.
- Hayati, A., Mattsson, M., Sandberg, M., 2014. Evaluation of the LBL and AIM-2 air infiltration models on large single zones: Three historical churches. *Build. Environ.* 81, 365–379.
- Kim, S., Paulos, E., 2010. inAir: Measuring and Visualizing Indoor Air Quality. Human - Computer Interaction Institute, Carnegie Mellon.
- Labat, M., Woloszyn, M., Garnier, G., Roux, J., 2013. Assessment of the air change rate of airtight buildings under natural conditions using the tracer gas technique. Comparison with numerical modelling. *Elsevier* 60, 37–44.
- Laporthe, S., Virgone, J., Castanet, S., 2001. A comparative study of two tracer gases: SF₆ and N₂O. *Build. Environ.* 36, 313–320.
- Laussmann, D., Helm, D., 2011. Air change measurements using tracer gases. *Chem. Emiss. Control Radioact. Pollut. Indoor Air Qual. InTech Rij.* <http://edoc.Rki.de/oa/articles/revSFJQq98Qgc/PDF/270A2TGPWvv0.Pdf>

- Lawrence Berkeley National Laboratory, 2006. Indoor-Outdoor air leakage of apartments and commercial buildings: Appendices (For California Energy Commission Public Interest Energy Research Program No. CEC-500-2006-111-AP).
- Lordache, V., Catalina, T., 2012. Acoustic approach for building air permeability estimation. *Build. Environ.* 57, 18–27.
- Lunden, M., Faulkner, D., Heredia, E., Cohn, S., Dickerhoff, D., Noris, F., Logue, J., Hotchi, T., Singer, B., Sherman, M.H., 2012. Experiments to Evaluate and Implement Passive Tracer Gas Method to Measure Ventilation Rates in Homes. Lawrence Berkeley Laboratory LBNL-5984E.
- Mattsson, B., Claesson, J., 2007. A Transient Pressurization Method for Measurements of Airtightness. *J. Build. Phys.* 31, 35–53.
- McWilliams, J., 2002. Review of Airflow measurement techniques (No. LBNL-49747). Lawrence Berkeley National Laboratory.
- Moderer, M.P., Sherman, M.H., 1986. AC pressurization: A technique for measuring the leakage area in residential buildings. *ASHRAE Trans.* 91(2B).
- Musser, A., Yuill, G., 1999. Comparison of residential air infiltration rates predicted by single-zone and multizone models. *ASHRAE Trans.* 951.
- Palmiter, L., Bond, T., 1991. Modeled and Measured Infiltration : A Detailed Case Study of Four Electrically Heated Homes. *Electr. Power Res. Inst.*
- Persily, A.K., 1997. Evaluating Building IAQ and Ventilation With Indoor Carbon Dioxide. *ASHRAE Transactions* 103.
- Riffat, S.B., 1991. Influence of Tracer-Gas on the Accuracy of Interzonal Airflow Measurements. *Appl. Energy* 38, 67–77.
- Sandberg, M., Blomqvist, C., 1985. A quantitative estimate of the accuracy of tracer gas methods for the determination of the ventilation flow rate in buildings. *Build. Environ.* 20, 139–150.
- Shao, L., Sharples, S., Ward, I.C., 1993. Tracer gas mixing with air. *Build. Serv. Eng. Res. Technol.* 14, 43–50.
- Shaw, C.Y., 1984. The Effect of tracer gas on the accuracy of air-change measurements in buildings. *ASHRAE Trans.* 90, 212–225.
- Shaw, C.Y., 1980. Wind and temperature induced pressure differentials and an equivalent pressure difference model for predicting air infiltration in schools. *ASHRAE Trans.* 86, 268–279.
- Shaw, C.Y., Tamura, G.T., 1980. Air-Tightness and air infiltration measurements” (MARK XI ENERGY RESEARCH PROJECT No. ISSN 0701-5232).
- Sherman, M., Moderer, M., 1986. Comparison of Measured and Predicted Infiltration Using the LBL Infiltration Model, in: Trechsel, H., Lagus, P. (Eds.), *Measured Air Leakage of Buildings*. ASTM International, 100 Barr Harbor Drive, PO Box C700, West Conshohocken, PA 19428-2959, pp. 325-325–23.
- Sherman, M.H., 1990. Tracer-gas techniques for measuring ventilation in a single zone. *Build. Environ.* 25, 365–374.
- Sherman, M.H., 1989. Uncertainty in Air Flow Calculations Using Tracer Gas Measurements. *Build. Environ.* 24, 347–354.

- Sherman, M.H., Grimsrud, D., 1980a. Measurement of infiltration using fan pressurization and weather data. Lawrence Berkely Labratory.
- Sherman, M.H., Grimsrud, D., 1980b. Measurement of infiltration using fan pressurization and weather data. Presented at the First Symposium of the air infiltration centre on instrumentation and measurement techniques, Windsor, England.
- Sherman, M.H., Matson, N.E., 2002. Air tightness of new houses in the U.S.: A preliminary report (LBNL report 48671). Lawrence Berkeley National Laboratory.
- Skon, J., Kauhanen, O., Kolehmainen, M., 2011. Energy consumption and air quality monitoring system, in: 2011 Seventh International Conference on Intelligent Sensors, Sensor Networks and Information Processing (ISSNIP). Presented at the 2011 Seventh International Conference on Intelligent Sensors, Sensor Networks and Information Processing (ISSNIP), pp. 163–167.
- Smith, P.N., 1988. Determination of ventilation rates in occupied buildings from metabolic CO₂ concentrations and production rates. *Build. Environ.* 23, 95–102.
- Sonoda, T., Peterson, F., 1986. A Sonic Method for Building Air-Leakage Measurements. *Appl. Sci.* 22, 205–224.
- Tzeng, C.-B., Wey, T.-S., 2011. Design and Implement a Cost Effective and Ubiquitous Air Quality Monitoring System Based on ZigBee Wireless Sensor Network, in: 2011 Second International Conference on Innovations in Bio-Inspired Computing and Applications (IBICA). Presented at the 2011 Second International Conference on Innovations in Bio-inspired Computing and Applications (IBICA), pp. 245–248. doi:10.1109/IBICA.2011.64
- Walker, I.S., Wilson, D.J., 1998. Field Validation of Algebraic Equations for Stack and Wind Driven Air Infiltration Calculations. *ASHRAE HVACR Res. J.* 4.
- Walker, I.S., Wilson, D.J., 1990. The Alberta Air Infiltration Model [WWW Document]. URL http://www.aivc.org/sites/default/files/airbase_3705.pdf (accessed 1.21.16).
- Walker, I.S., Wilson, D.J., Sherman, M.H., 1997. A comparison of the power law to quadratic formulations for air infiltration calculations. *Energy Build.* 27.
- Walker, Wilson, D.J., 1990. The Alberta Air Infiltraion Model. The University of Alberta, Department of Mechanical Engineering, Alberta.
- Wang, W., Beausoleil-Morrison, I., Reardon, J., 2009. Evaluation of the Alberta air infiltration model using measurements and inter-model comparisons. *Build. Environ.* 44, 309–318
- Watanabe, Y., Kobayashi, H., Utsumi, Y., n.d. DEVELOPMENT OF VALIDATION OF AC-PRESSURIZATION MEASURING OF LEAKAGE AREA OF HOUSES.
- Wilson, D.J., Walker, I.S., 1991. Wind shelter effects on air infiltration for a row of houses. *12 AIVC Conf.* 1, 335–346.
- Younes, C., Shdid, C.A., Bitsuamlak, G., 2012. Air infiltration through building envelopes: A review. *J. Build. Phys.* 35, 267–302.

11 VITA

Achalu Tirfe, P.E.

Mechanical Engineer

30 Bradhurst Ave, Apt. #5B, Syracuse, NY 13210

(360) 593-4437 • achalu.tirfe@gmail.com

PROFESSIONAL EXPERIENCE

Senior Mechanical Engineer

4/2014 - Present

UTC Building and Industrial System (BIS), East Syracuse, NY

- Develop performance prediction model for package chillers
- Develop chiller component model
- Provide support for the existing E-CAT chiller models

Research/Teaching Assistant

8/2010 – 04/2014

Department of Mechanical and Aerospace Engineering, Syracuse University,

Syracuse NY

- Design and built wireless low Cost IAQ monitoring system(CO2, T, RH, Occupant)
- Develop a method to detect occupants by passively detection their smart phone

- Design, set up and run experiment for building envelope system study (heat, air and moisture transport, blower door test, tracer gas test, infrared scanning)
- Constructed Air Change Rate measuring device (Tracer gas method: constant concentration)
- Designed and built single zone HVAC system and thermal manikin with four zone control system
- Calibrate the thermocouples, heat flux sensors, pressure transducer, and flow and mass meter.
- Teaching assistant
 - HVAC Lab ,Mechanical and Aerospace Lab, Engineering material ,Mechanical vibration

Thermal Analyst (MSc. Thesis Work)

2/2009 - 12/2009

Metso Paper, Sundsvall, Sweden

- Simulated two phase flow analysis of water spray using ANSYS-CFD
- Performed FEA of transit thermal analysis using ANSYS Workbench
- Carried out thermal fatigue analysis

Project Supervisor

3/2006 - 9/2007

Daylight Applied Technology (MIDROC Group), Addis Ababa, Ethiopia

- Designed and supervised installation HVAC

- Designed and managed the installation of hydronic system for cooling glass furnace
- Supervised the installation of a glass furnace, raw material processing and bottle making line
- Designed and constructed lime stone crushing plant and its control system
- Supervised installation of three large capacity compressors and air supply system for cooling and pneumatic system and oxygen separation plant

Supervisor, Technical Assistance and Design Engineer

9/2002 - 3/2006

Kombolcha Steel Products Industry (MIDROC Group), Addis Ababa, Ethiopia

- Designed, manufactured and installed cooling tower
- Installation and commission of hot dip galvanizing plant and waste water treatment plant
- Installation and commissioning of PLC controlled ribbed sheet and corrugated
- Designed and installed fuel supply system
- Supervised the manufacture and construction of steel structures
- Managed wire products machinery installation (nail making, galvanizing, drawing, weaving, and others)
- Renovated nail polishing machine and carton packing machine.
- Developed plant layout

EDUCATION

Ph.D. in Mechanical Engineering

August 2017

Title: “Integrated Monitoring and Modeling of Energy Flow and IEQ Conditions Approach for Diagnosis of Building Envelope Deficiency and IAQ Problems in Houses.”

Syracuse University, Syracuse, NY, USA

M.Sc. in Mechanical Engineering

June 2010

Sustainable Energy Engineering

Royal Institution of Technology, Stockholm, Sweden

B.Sc. Mechanical Engineering

July 2002

Bahir Dar University, Bahir Dar, Ethiopia

PROFESSIONAL REGEISTRATION

- Professional Engineer , State of California
- LEED GA

Membership

ASHRAE, NBSE